

「HAND TOOLS & ACCESSORIES」

BIT TIPS & ACCESSORIES

DE.1045.2



BHM.075

IB.025.2



IB.825.2



ABC-123



Code

Barcode



Description



Size



Ctn

IB.025.2	9315778996037
IB.425.2	9315778997256
DE.1045.2	9315778996044
BHM.075	9315778996051
IB.825.2	9315778990769
IB.132.2	9315778996068
IB.150.2	9315778997102

Bit Tip No. 2 Single Ended 10pkt	6.5mm x 25mm	10
Bit Tip No. 2 Single Ended USA 1pkt	6.5mm x 25mm	100
Bit Tip No. 2 Double Ended 4pkt	6.5mm x 45mm	10
Bit Tip Holder Magnetic 1pkt	6.5mm x 75mm	10
Depth Gauge No. 2 4pkt	95mm x 53mm	5
Bit Tip No. 2 Single Ended 4pkt	132mm	10
Bit Tip No. 2 Single Ended 4pkt (for CSG-2000, CSG-4000L & CSG4002L)	154mm	10

BOLT CUTTERS WALLBOARD

ABC-123



Code

Barcode



Size



Ctn

BC-350	9315778995399	350mm	6
BC-450	9315778995405	450mm	6



BC-450



62-008

BRUSHES TEXTURE WALLBOARD

ABC-123



Code

Barcode



Ctn

62-008	9315778998116	6
--------	---------------	---

BUCKETS

ABC-123



Code

Barcode



Description



Size



Ctn

GP-942*	9315778001809	Gauge Pot	10 litre	12
PB-5^	9315778998543	Flexible Bucket	10 litre	25
PB-10-B	9315778990233	Blue Plastic Bucket with Lid	20 Litre	10
N-73	9315778990585	Replacement Lid for PB-10-B		10

^ Plastic Buckets 10L (PB-5) are packaged in cartons of 25 for transportation purposes
 * Gauge Pots (GP-942) are ordered in multiples of 12 for transportation purposes

GP-942



PB-5



PB-10-B



CART PLASTERBOARD

The Wallboard Tools Plasterboard Trolley speeds up the movement of sheeting on site. It is designed to move quantities of sheeting, paneling, plywood and other construction materials while reducing physical strain.

- Sturdy tubular design with welded steel construction
- One fixed & three swivel castors for optimal manoeuvrability
- “No mark” polyurethane castors
- Deck shape makes the cart easier to navigate in tight spaces, around corners and through door ways
- Deck size 1120mm (w) x 290mm (d)
- Dismantles to fit in the boot of most cars
- Carry sheets up to 3.6m in length
- Designed to carry loads up to 1350kgs



Load Rating
1350kg



Safety
Certificate
Available

- ✓ Push cart from end of sheets
- ✓ Always keep lockable castor locked
- ✓ 2 person push when fully loaded
- ✗ Do not load sheets longer than 3.6m
- ✗ Do not stand beside sheets when moving

ABC-123

Code

DC-1350



Barcode

9315778998741



WATCH ON



Tubular frame shaped to enable improved cornering maneuverability

TELPRO MATERIAL CART

Designed as a plasterboard cart, the Telpro Material Cart is truly multi-purpose. The open front allows one person load and unload without damaging the boards or your hands.



Load Rating
1360kg

DC-1270



CONTINUED NEXT PAGE...



- Handles collapse for easy transportation
- Converts to a flatbed multi-purpose cart
- Sturdy 1360kg load rating
- Takes up to 3.6m plasterboard sheets
- One swivel locking caster



ABC-123	
Code	Barcode
DC-1270	9315778002295

CARTRIDGE GUN BARREL

ABC-123			
Code	Barcode	Description	Ctn
SV-670	9315778996266	Cartridge Gun	6
SV-NS	9315778999830	Small Nozzle 6pkt	5
SV-NL	9315778999823	Large Nozzle 6pkt	5



CARTRIDGE GUN PARALLEL FRAME

ABC-123			
Code	Barcode	Size	Ctn
COW-215	9315778995368	225mm	6

CEMENT SHEET CUTTERS

ABC-123 Code	Barcode Barcode	Description
520	9315778998871	Cement Sheet Cutter Wallboard
24-317	9315778998253	Score & Snap Knife Wallboard

Size	Ctn
550mm	10
265mm x 25mm	12

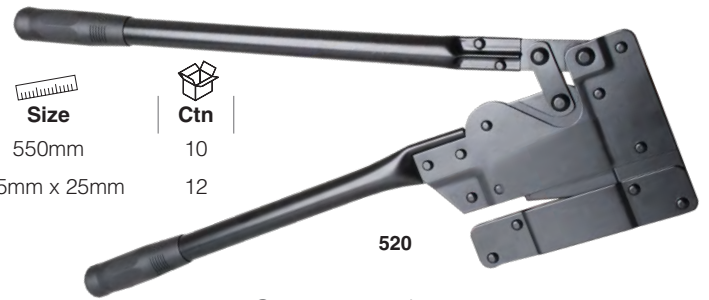

520

24-317



- Cuts cement sheets up to 10mm
- Soft rubber grip handles
- Rust resistant paint finish



47-099

47-900

47-700



C-8R

C-8B

CHALK LINES

ABC-123 Code	Barcode Barcode	Description	Size	Ctn
47-700	9315778995429	Wallboard Speedwind Chalk Line	30m	6
47-900	9315778992305	Wallboard Metal Chalk Line	30m	6
47-099	076174470994	Stanley Metal Chalk Line	30m	2
47-440	076174474404	Stanley Plastic Chalk Line	30m	6
C-8B	024721500076	Blue Chalk	8oz	6
C-8R	024721500120	Red Chalk	8oz	6

08-500



CIRCLE CUTTERS

ABC-123 Code	Barcode Barcode	Description
08-500	9315778998628	Calibrated Circle Cutter Wallboard

Size	Ctn
210mm	6

CA-200



CITRIC ACID

ABC-123 Code	Barcode Barcode	Size	Ctn
CA-200	9315778991971	200g	6

**CORNER TOOL
ADJUSTABLE**

A great solution for feathering unusual internal corners between 88° - 150°



Adjusts Between
88°-150°



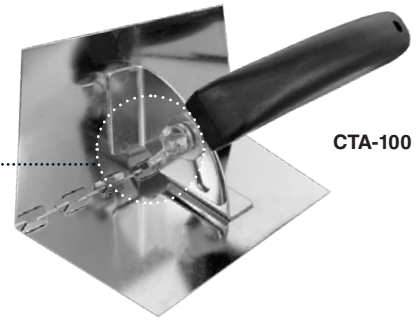

Stainless
Steel
Blade



CTA-100

ABC-123
Code
CTA-100



Barcode
9315778991957

Description
Adjustable Corner Tool Wallboard

Size
80mm

Ctn
12

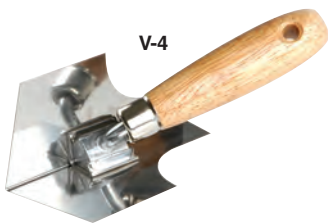
CORNER TOOLS INTERNAL



V-4



5560

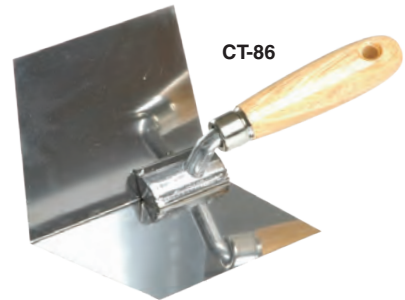

CT-86



CT-90

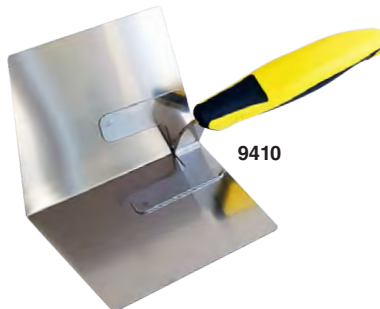

9410

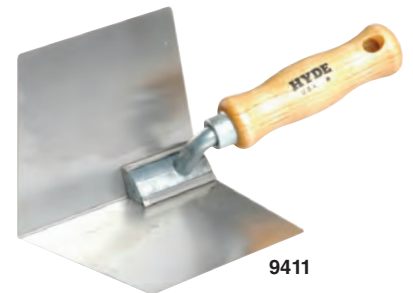

9411

ABC-123
Code

Barcode

Description

Size

Ctn

V-4	9315778990059	Wallboard Corner Tool with Wooden Handle	50mm	10
V-6	9315778996761	Wallboard Corner Tool with Rubber Handle	50mm	10
5560	9315778990677	Wallboard Plastic DIY Corner Tool	60mm	24
CT-86	9315778993760	Wallboard Stainless Steel Corner Tool with Wooden Handle	100mm	5
CT-90	9315778996754	Wallboard Stainless Steel Corner Tool with Rubber Handle	100mm	6
9410	079423094101	Hyde Stainless Steel Corner Tool with Maxx Grip	100mm	5
9411	079423094118	Hyde Stainless Steel Corner Tool with Wooden Handle	100mm	5

CORNER FLUSHER

- Short handle fits into tight spots
- Made of hardened and tempered steel
- Handle material reduces hand moisture for improved grip
- Subtle radius nose to prevent gouging tape



Made in USA



Description
Corner Hand Flusher



Size
80mm



CT-224



ABC-123

Code
CT-224



Barcode
099922352205

CORNER BEAD TOOLS

The Clinch-On-Tool installs metal corner bead without nails or staples. One blow from the rubber mallet crimps each side locking it into place.

CO-2RK



CO-2

- Heavy duty blade bites into metal and plasterboard
- Normally needs only four hits to install a 2.4m bead
- Durable spring-loaded plunger head designed for rugged use
- Rubber mallet included

ABC-123

Code
CO-2
CO-2A
CO-2RK



Barcode
049727710014
049727710021
049727710038



Description
Clinch-on-Tool Wal-Board USA
Clinch-on-Tool Wal-Board USA
Clinch-on-Tool Repair Kit Wal-Board USA



Size
28mm
32mm



Ctn
2
2
2

CRIMPING TOOLS WALLBOARD

Stud Crimpers are designed to secure or crimp together metal stud and track without the use of fasteners.



11-25



11-20



WATCH ON



- Crimps metal together up to 0.8 gauge
- Features comfortable non-slip handle grips
- Increases construction speed
- Made from high quality carbon steel

ABC-123

Code
11-20
11-25



Barcode
9315778998109
9315778000932



Size
250mm
320mm



Ctn
6
6

**CUTTING KNIVES
FIXED BLADE**



Fixed Blade



K-2006

- Heavy duty fixed blade cutting knife
- Tough full die-cast aluminium body
- Ergonomic design for greater comfort
- Takes all standard shaped blades
- Includes plastic belt holster

ABC-123
Code
K-2006

Barcode
9315778994613

Ctn
12



Fixed Blade

10-299



K-2100



K-899



ABC-123
Code
K-2100
10-299
K-899

Barcode
9315778996112
076174102994
9315778002875

Description
Quick Change Knife with Rubber Grip Wallboard
Fixed Blade Knife Stanley
Quick Change Fixed Blade Knife

Ctn
12
20
30

INSULATION KNIFE



K-3280

This multi functional insulation cutting knife is great for cutting most types of hard and soft insulation effortlessly. It comes with a sheath to protect the dual serrated cutting blade that is made from high quality stainless steel, engineered to stay sharper for longer.



Rubber Handle

ABC-123
Code
K-3280

Barcode
9315778002561

Size
280mm

CUTTING KNIVES RETRACTABLE



Retractable Blade

10-099



ABC-123
Code
10-099

Barcode
076174100990

Description
Retractable Blade Cutting Knife Stanley

Ctn
20

CUTTING KNIVES UTILITY KNIFE



K-3100

- Quick change blade
- Easy folding action
- Finger grip handle
- Finger lock back
- Belt or pocket clip
- 5 blades included

ABC-123
Code
K-3100

Barcode
9315778002868

Description
Quick Change Folding Utility Knife

Ctn
12

CUTTING KNIFE BLADES

Replacement blade packs for your favourite cutting knives

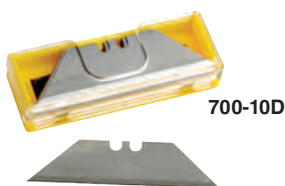

700-10D



700-5



42101

- Excellent durability
- Long life blade
- Available in a carded 5pkt (700-5) in 10pkt dispenser (700-10D) and 100pkt dispenser (42101)



Made From
Quality SK2
Steel



Sub-Zero
Tempered

ABC-123
Code
700-5
11-921
700-10D
42101

Barcode
9315778991605
5000366119212
9315778995375
9315778992299

Description
Sub-Zero Blades 5pkt Wallboard
Blades 5pkt Heavy Duty Stanley
Sub-Zero Blades 10pkt in Dispenser Wallboard
Sub-Zero Blades 100pkt in Dispenser Wallboard

Ctn
20
10
24
10

CUTTING KNIFE SCORE & SNAP



24-317

ABC-123
Code
24-317

Barcode
9315778998253

Ctn
12

DRILL BIT COUNTER SINKING

ABC-123 Code	Barcode	Description	Size	Ctn
CST-01	9315778990882	10 Gauge Countersinking Bit Tip Wallboard	6mm	10



DRILL BIT DOUBLE ENDED

ABC-123 Code	Barcode	Size	Ctn
DE-30	9311963000145	3.3mm	100



DRILL BITS MASONRY MULTI-FIT

ABC-123 Code	Barcode	Size	Ctn
SDS-5110	9311963152189	5 x 50 x 110mm	10
SDS-5160	9311963152264	5 x 100 x 160mm	10
SDS-55110	9311963152196	5.5 x 50 x 110mm	10
SDS-6110	9311963152202	6 x 50 x 110mm	10
SDS-6160	9311963152288	6 x 100 x 160mm	10
SDS-65110	9311963152219	6.5 x 50 x 110mm	10
SDS-65160	9311963152295	6.5 x 100 x 160mm	10



DROP SHEET PLASTIC

ABC-123 Code	Barcode	Size	Ctn
DS-2636	9312492048967	2.6m x 3.6m	25

DUST MASKS



SCP1085



627-12



Plastic Valve



P2 Australian Standard

ABC-123 Code	Barcode	Description	Ctn
SCP1085	9310679018796	P2 Respirator Dust Mask SafeCorp	1
SCP1070	9310679018765	P2 Respirator Filter SafeCorp	20
SCP1065	9310679018758	P2 Respirator Cartridge 2pkt SafeCorp	1
627-12	9315778993401	P2 Dust Mask with valve 12pkt Wallboard	20

FLOOR SCRAPER & BLADE

ABC-123
Code

FS-6

FSB-14



Barcode

9315778992060

9315778990790



Description

Floor Scraper with Steel Handle

Floor Scraper Blade



Size

350mm

350mm



Ctn

6

6

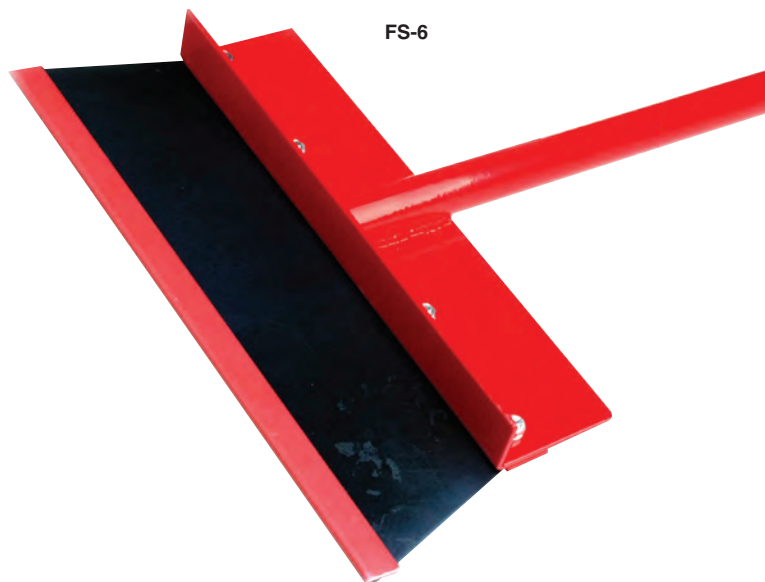
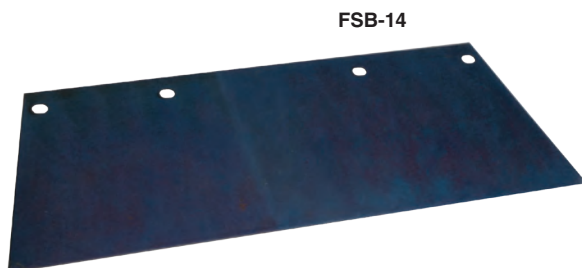

GRAPHITE POWDER

The ultimate lubricant for maintaining your power tools.

ABC-123
Code

GP-30



Barcode

9315778003858



Size

30g





GLUE KNIFE

The ideal tool for applying stud adhesive with the least amount of mess.

ABC-123 Code	Barcode	Size	Ctn
GKP-200	9315778003230	200mm	12



GKP-200

HAMMERS CLAW

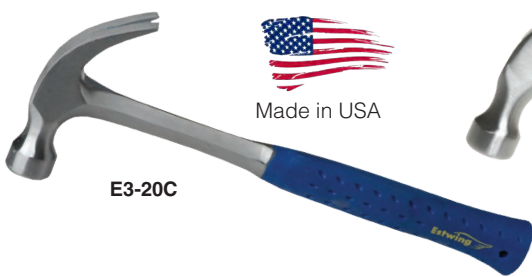

E3-20C



Made in USA



E-20C



WE-20C

ABC-123 Code	Barcode	Description	Weight	Ctn
WE-20C	9315778996099	20oz Hammer with Steel Shaft Wallboard	560g	6
E-20C	034139612018	20oz Hammer with Leather Grip Estwing	560g	4
E3-20C	034139624615	20oz Hammer with Blue Grip Estwing	560g	4

HAMMERS PLASTERBOARD



Made in USA



E3-11



WE-14

ABC-123 Code	Barcode	Description	Weight	Ctn
E3-11	34139622215	11oz Steel Hammer Estwing	312g	4
WE-14	9315778990035	12oz Hammer with Steel Shaft Wallboard	340g	6

HAWKS

DH-40 / DH-50

- Lightweight but durable
- Radius corners for safety
- Rigid aluminium plate
- Rubber donut reduces fatigue on the hand



Rubber Handle



Aluminium Plate



Wooden Handle



Aluminium Plate



Traditional Wooden Handle



Tempered Aluminium Plate



DH-50A

- Grain finish and circular grooves reduces material sliding
- Corners are rounded for safety
- Bolts extend through natural wood handle and screws to plate
- Rubber donut reduces fatigue

DH-55

- 325mm square
- Premium magnesium plate
- Stronger and lighter than aluminium hawk
- Durable professional tool
- Rubber donut reduces fatigue



Rubber Handle



Strong Magnesium Plate



9073

- Designed for plastering & masonry work
- The grooved aluminium plate provides a non-slip surface
- Sponge rubber cushion for comfort
- Lighter gauge aluminium plate to reduce weight
- Open handle end design



Aluminium Plate



Rubber Handle



ABC-123

Code



Barcode



Description



Size



Ctn

DH-40

9315778990134

Aluminium Hawk with Rubber Handle Wallboard

300 x 300mm

4

DH-60

9315778001717

Aluminium Hawk with Wooden Handle Wallboard

300 x 300mm

4

DH-50A

049727470024

Aluminium Hawk with Wooden Handle Wal-Board USA

312 x 312mm

6

DH-50

9315778990257

Aluminium Hawk with Rubber Handle Wallboard

325 x 325mm

4

DH-55

9315778990448

Magnesium Hawk with Rubber Handle Wallboard

325 x 325mm

4

9073

079423090738

Aluminium Hawk with Rubber Handle Hyde

325 x 325mm

5

JOINT KNIVES CARBON STEEL

PRO-GRIP SERIES WALLBOARD



3850



3550



3250

ABC-123

Code



Barcode



Size



Ctn

3150	9315778992428	32mm	12
3250	9315778992435	50mm	12
3350	9315778992442	75mm	12
3550	9315778992459	100mm	12
3750	9315778992466	125mm	12
3850	9315778992473	150mm	12



Hammer Head End



Rubber Handle



Flexible Carbon Steel

BLACK & SILVER SERIES HYDE

ABC-123

Code



Barcode



Size



Ctn

2005	079423020056	19mm	5
2000	079423020001	32mm	5
2100	079423021008	38mm	5
2250	079423022500	51mm	5
2350	079423023507	76mm	5
2500	079423025006	89mm	5
2550	079423025501	102mm	5
2750	079423027505	127mm	5
2850	079423028502	152mm	5
2990	079423029905	203mm	5
2880	079423028809	254mm	5



2850



2550



2350



Flexible Carbon Steel



Nylon Handle



Full Tang Construction

PRO PROJECT SERIES HYDE

ABC-123

Code

6351

6571

6872



Barcode

079423063510

079423065712

079423068720



Size

76mm

102mm

152mm



Ctn

5

5

5



Flexible Carbon Steel



Soft Grip

6351



6571



6872



PROFESSIONAL SERIES WALLBOARD

ABC-123

Code

5040

5065

5070

5080

5090

5095

5100



Barcode

9315778994262

9315778998215

9315778994286

9315778999939

9315778994293

9135778998208

9135778001946



Size

50mm

75mm

100mm

125mm

150mm

200mm

250mm



Ctn

12

12

12

12

12

12

12

5065
splayed



5070



Flexible Carbon Steel



Full Tang Construction



Polypropylene Handle

JOINT KNIVES STAINLESS STEEL

PRO-GRIP SERIES WALLBOARD

ABC-123 Code	Barcode	Size	Ctn
8250	9315778992510	50mm	12
8350	9315778992527	75mm	12
8550	9315778992534	100mm	12
8750	9315778992541	125mm	12
8850	9315778992558	150mm	12



Durable
Stainless
Steel



Rubber
Handle



Hammer
Head End

ALL STAINLESS SERIES WALLBOARD



ABC-123 Code	Barcode	Size	Ctn
7020	9315778999960	50mm	12
7030	9315778999977	75mm	12
7040	9315778999984	100mm	12
7050	9315778999991	125mm	12
7060	9315778000017	150mm	12
7080	9315778001861	200mm	12
7100	9315778001878	250mm	12

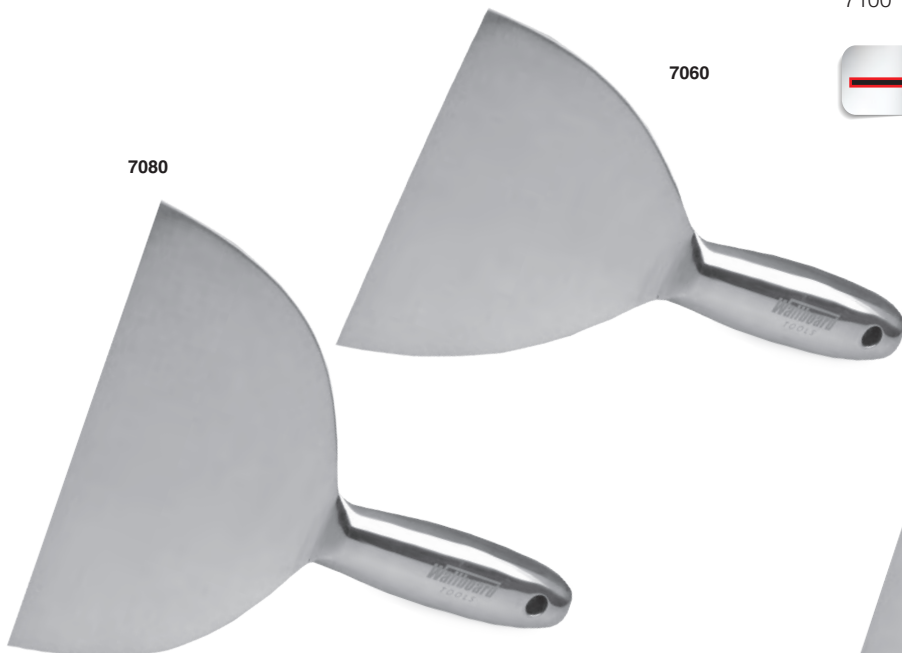

One Piece
Stainless
Steel



Flexible
Blade



Easy
Clean

STAINLESS SERIES WITH RUBBER GRIP WALLBOARD

ABC-123 Code	Barcode	Size	Ctn
7025	9315778000024	50mm	12
7035	9315778000031	75mm	12
7045	9315778000048	100mm	12
7055	9315778000055	125mm	12
7065	9315778000062	150mm	12



- One Piece Stainless Steel
- Rubber Grip
- Flexible Blade
- Easy Clean

BLACK & SILVER SERIES HYDE

ABC-123 Code	Barcode	Size	Ctn
1040	079423010408	38mm	5
1340	079423013409	76mm	5
1540	079423015403	102mm	5
1740	079423017407	127mm	5
1840	079423018404	152mm	5



- Durable Stainless Steel
- Nylon Handle
- Full Tang Construction

PRO STAINLESS SERIES HYDE



ABC-123 Code	Barcode	Size	Ctn
6358	079423063589	76mm	5
6578	079423065781	102mm	5
6878	079423068782	152mm	5

- Durable Stainless Steel
- Soft Grip
- Hammer Head End

PLASTIC JOINT KNIVES WALLBOARD

ABC-123 Code	Barcode	Size	Ctn
5520	9315778990639	50mm	24
5530	9315778990646	75mm	24
5540	9315778990653	100mm	24
5550	9315778990660	150mm	24
5580	9315778996907	200mm	24



JOINT TAPE HOLDER

ABC-123 Code	Barcode	Description	Ctn
41-001	49727410013	Tool Holder Paper Tape Reel WBT	6
41-002	9315778998604	Paper Tape Dispenser WBT	6



LEVELS MAGNETIC

ABC-123 Code	Barcode	Size	Ctn
26-12	9315778998123	1200mm	5
26-20	9315778998130	2000mm	5

- Shock absorbing ends
- Durable block vials
- Tough powder coated aluminium alloy
- Soft grip rubber handles
- Magnetic - great for working with stud and track
- Available in sizes 1200 & 2000mm

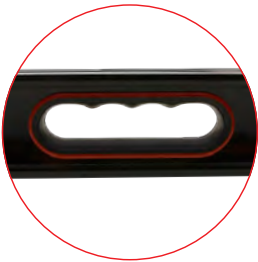

LIGHTS

3W LED RECHARGEABLE HEADLAMP



905200

- 3 Watt headlamp
- 3 mode settings - high, low, and flash
- Bright 200 lumens on high
- Dimmed 100 lumens on low
- 50m maximum light distance
- 8 hour maximum run time
- Adjustable angle flexibility
- Comfortable adjustable elastic head band
- USB charging cable included
- Water resistant to IPX4



ABC-123

Code

905200



Barcode

9315778002707



Description

3W LED Rechargeable Headlamp WBT



Ctn

10

LED WIDE VIEW HEAD LAMP



Wallboard's Wide View Head Lamp gives you a full 230° of bright illumination. With 350 lumens, nothing will be left in the dark! It has an easy control button on the left side to switch through the 5 available modes, and a sensor option that allows you to turn the light on and off with the simple wave of your hand! Get up to 3 hours when using 100% Wide View COB LED and up to 8 hours when using the side beam XPE LED light.

- 350 lumens
- Motion sensor
- 5 modes
- 230° COB LED coverage
- COB LED wide view
- XPE LED side beam
- USB charging
- Adjustable band
- Light weight (70g)
- IPX4 rated



ABC-123

Code

905250



Barcode

9315778003780



Description

Wide View LED Head Lamp WBT

LED UNIVERSAL FLOOD LIGHT



10W	30W
10W COB LED	30W COB LED
3.7v 4400mAh	3.7v 8000mAh
10hrs lighting (Low mode)	7-8hrs lighting (Low mode)
H-1000LM, M-500LM, L-250LM	H-2800LM, M-2000LM, L-1200LM

- 3 lighting modes
- LED charge battery indicator
- Light swivel all directions
- IP54 water & dust resistance
- Rechargeable Li-ion battery
- Overcharge or discharge protection

ABC-123 Code	Barcode	Description	Ctn
905310	9315778003025	10W LED Universal Light WBT	10
905330	9315778003018	30W LED Universal Light WBT	10

30W LED RECHARGEABLE FLOOD LIGHT



- Powerful 30W COB LED
- 3.7V 7500mAh rechargeable Li-ion battery
- 2 lighting modes - High 2800LM - Low 1400LM
- 4-5 hours of lighting time while on Low mode
- Light swivels 360deg on axle with locking bracket
- Handy LED battery charge level indicator
- Overcharge or discharge protection
- 5V2A AC charger and USB cable included
- Sturdy frame protects light and acts as a handle
- Rated to IP54 for water and dust resistance

ABC-123 Code	Barcode	Description	Ctn
905230	9315778002721	30W LED Rechargeable Flood Light WBT	8

30W LED FLOOD LIGHT SKIN



- 3500 lumens
- Standard battery interface - Makita® 18V Li-ion
- Highly efficient SMD chip output
- 3 light settings - high, medium, low
- Durable ABS housing
- Foldable stand
- CCT 5000K - cool white light

*Disclaimer on next page

ABC-123 Code	Barcode	Description	Ctn
905430	9315778003735	30W LED Flood Light Skin WBT	10

FOLDED/HOOK



OPEN/MAGNETIC



BATTERY ADAPTER OPTIONAL



To suit DeWALT® or Milwaukee® 18V Li-ion batteries sold separately

905422

20W WORK LIGHT SKIN

- Powerful 1800 Lumens
- Use with 360° diffuser or as spotlight
- Made from hard wearing aluminium & polycarbonate
- Skin suits Makita® 18V Li-ion batteries (sold separately)

*Makita® is a registered trademark of Makita Corporation. DeWALT® is a registered trademark of Black & Decker Inc. Milwaukee® is a registered trademark of Milwaukee Electric Tool Corporation. Wallboard Tools is a registered trademark of Wallboard Tool Co. Pty Ltd.



905420

905422



To suit DeWALT or Milwaukee 18V Li-ion batteries

ABC-123
Code

905420

905422



Barcode

9315778003049

9315778003056



Description

20W Work Light Skin WBT

Work Light Battery Adapter



Ctn

8

5000lm LED EXTENDABLE DUAL-HEADED LED WORK LIGHT



905500

- Twin Head – adjustable in all directions
- 5000lm high, 1500lm medium, 500lm low
- Runs on 2300lm when charging cable is plugged in
- 7 hours run time on low
- Day light and white light modes
- Battery life display
- Folds for easy transportation
- Built in carry handle
- Lock at any desired height
- 4.6kg net weight
- Rechargeable battery – cord and adapter included

ABC-123
Code

905500



Barcode

9315778003261



Description

5000lm LED Twin Head Rechargeable Tripod Light WBT



10W HANDHELD JOB LIGHT

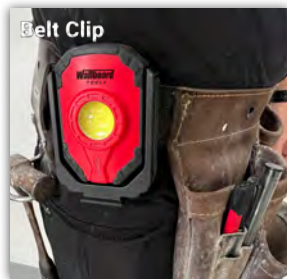

- 1000 Lumens
- Battery life display
- 3 Modes (High, low and strobe)
- Lasts 4 hours on low mode
- Rotates 360°
- USB cable included

- Impact resistance
- Rubber grips
- Foldable hook
- Light weight (250g)
- USB charging

ABC-123
Code
905210

Barcode
9315778003797

Description
10W Handheld Job Light WBT

5W LED RECHARGEABLE WORK LIGHT



905205

- 5W 500LM COB LED work light
- 1W 70LM LED torch
- 3.7V 2400mAh rechargeable Li-ion battery
- Recharges via USB cable (included)
- 6-7 hrs Torch operating time or 2-2.5 hrs for COB
- Work light rotates 90° and Torch 180°
- Handy LED battery charge level indicator
- On/Off switch with dimmer function
- Magnet at back for mounting to ferrous metal
- Hands free retractable hanging hook

ABC-123
Code
905205

Barcode
9315778002738

Description
5W LED Rechargeable Work Light WBT



MITRE BOXES

Our selection of Mitre Boxes will assist you in making clean, precise cornice cuts.



STANDARD MITRE BOX

ABC-123 Code	Barcode	Description	Ctn
MB-90	9315778990301	Cuts 55, 75 & 90mm Cornice	10

- Sides and base are 20mm thick ply wood and glued together for added strength
- Steps in base of mitre box to accommodate 55mm, 75mm and 90mm cornice
- Slots are not full depth to maintain strength while box is in transit



Quality Ply Wood



Cuts at 45°



MB-90

DUAL CUT MITRE BOXES



MBD-90

- Made from construction grade plywood
- Sides and base are both 20mm thick and glued together for added strength
- Steps in base to accommodate 55mm, 75mm and 90mm cornice
- Cuts are not full depth to maintain strength while box is in transit



Cuts at 45° & 135°

ABC-123 Code	Barcode	Description	Ctn
MBD-90	9315778992794	Cuts 55, 75 & 90mm Cornice	10
MBD-100	9315778994910	Cuts 55, 75, 90 & 100mm Cornice	10

ADJUSTABLE MITRE BOX

ABC-123 Code	Barcode	Size	Ctn
MBA-300	9315778994354	300mm	4

- Ideal for larger ornate cornices
- Box adjusts to accommodate and accurately cut cornice up to 300mm wide
- The overall length is 600mm
- Supplied with two 150mm steel brackets for added strength
- Packed in kit-form and assembles in minutes



Quality Ply Wood



Cuts at 45° & 90°



MBA-300

PLASTIC MITRE BOX



14-400



14-410

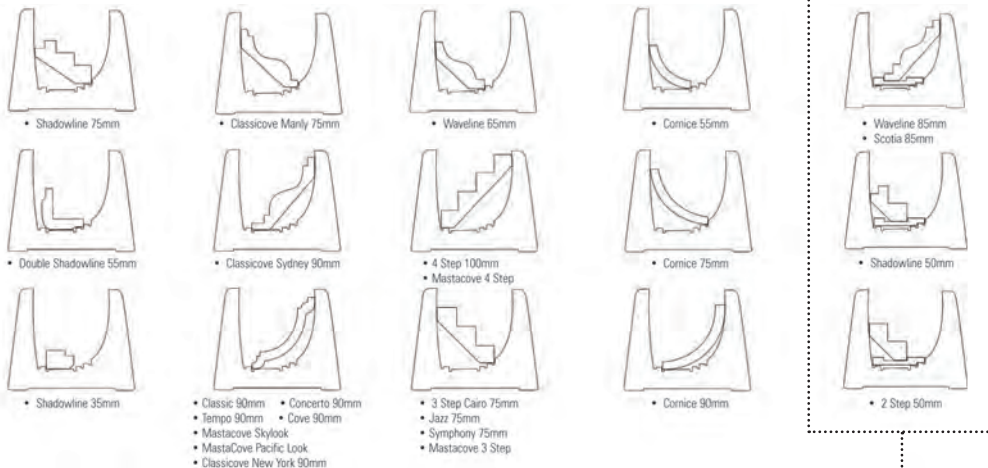

The plastic mitre box is able to accommodate twelve different profiles of cornice. Three further cutting profiles are achieved with addition of the 14-410 timber insert.

- Weather resistant plastic design
- Lasts more than three times longer than traditional ply mitre boxes
- Five cornice steps are moulded into the box which accommodates 12 different cornice profiles
- Three further profiles are achieved with additional timber insert (14-410)



ABC-123
Code

14-400

14-410



Barcode

9315778998147

9315778998154



Description

Plastic Mitre Box

Timber Insert for Plastic Mitre Box

Cuts at 45°, 90° & 135°

MITRE MARKER

ABC-123
Code

5500



Barcode

9315778996808



Description

Plastic DIY Mitre Marker



Ctn

20

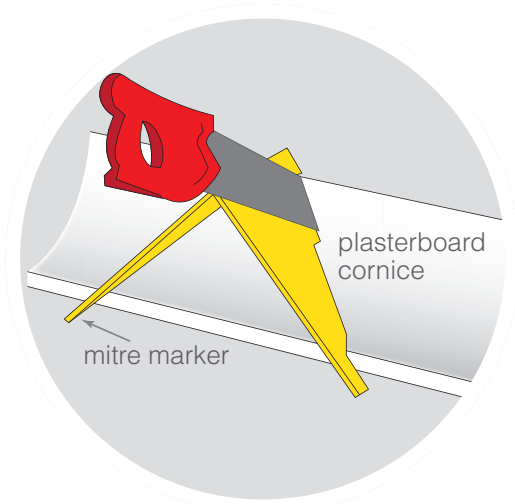

5500



MIXERS

Blitza Mixer.
9107



- Draws material quickly - Original design
- Round edges protect bucket from damage
- Stainless steel
- Less bucket spin
- Easy to clean

43-001

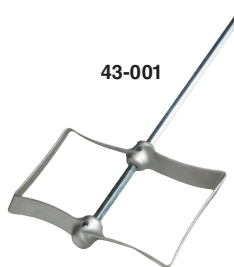

- Simple robust design
- Durable metal construction
- 600mm shaft and 200mm wide head

46565



- Hexagon shaped 760mm shaft with 100mm diameter head
- Zinc plated for corrosion resistance and easy cleaning
- For use in drills with 10mm or larger chuck

9105



- Two fixed fan shaped blades
- The mixer is zinc plated with 125mm diameter blades
- 10mm x 600mm hexagon steel shaft

 **EC28**



- Durable polypropylene mixing paddle
- Easy flow design results in smooth, even mix
- Mixer comes with a 700mm shaft that will fit any standard mixing drill

PM-50



- Two fixed blades at 120mm diameter
- 600mm long M14 shaft for screw fitting
- For use with the PM-1100 Wallpro Power Mixer

PMB-3

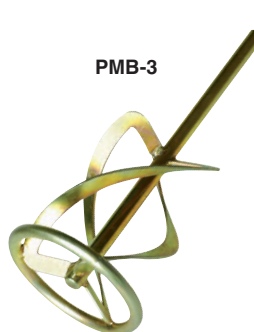

- Three fixed blades at 120mm diameter
- 600mm long M14 shaft for screw fitting
- For use with the PM-1100 Wallpro Power Mixer

DT-MIXM8
DT-MIXM8-M14



- Available with a 10mm Hex Thread or an M14 Thread
- Compatible with corded and cordless (18v) model drills
- Rubber blade eliminates bucket gouging

DT-TURBO



- Delko Turbo fits effortlessly to corded and cordless (18v) model drills
- Edge to edge mixing – no need to stop and stir
- Reduces mixing time

ABC-123 Code	Barcode	Description	Size	Ctn
46565	9315778995061	Mud Slinger Wallboard	100 x 600mm	6
PM-50	9315778998444	2 Blade Mixer for Wallpro PM-1100	120 x 600mm	1
PMB-3	9315778997904	3 Blade Mixer for Wallpro PM-1100	120 x 600mm	1
9105	9315778992053	Fan Mixer with 2 Fixed Blades Wallboard	125 x 600mm	6
43-001	049727430011	Quick Mixer Wal-Board USA	200 x 600mm	6
DT-TURBO	0072632835022	DELKO® TURBO	60 x 605mm	1
9107	9315778002943	Blitza Mixer	100 x 610mm	16
DT-MIXM8	0670087124120	DELKO® MIXM8	185 x 645mm	10
DT-MIXM8-M14	0670087124328	DELKO® Mixer Paddle MIXM8 M14 Thread	185 x 645mm	10
EC28	099922398166	Tornado Mixer Pivot Blade	175 x 700mm	6

MUD PANS PLASTIC

ABC-123 Code	Barcode	Size	Ctn
PP-12	049727270020	300mm	12
PP-14	049727270044	350mm	12

PP-14



PUMP

SPEED FILLER PUMP

The Wallboard Tools Speed Filler Pump is an economical, mechanical loading and filling solution. It features a specially shaped flat nozzle end that fits the mouths of Flat Boxes for fast filling – and the best part? It rinses clean in just seconds.



SFP



ABC-123 Code	Barcode	Ctn
SFP	9315778001939	10

- Specially designed flat nozzle
- Fill flat boxes, mud boxes, Plastic tapers and more...
- Draw compound straight from the bucket
- 600mm long tube
- Lightweight at just under 1kg empty
- Rinse clean in just seconds
- Unscrew the top and remove the piston for a more thorough clean

NAIL BAGS



BT-99-2

- Complete with web belt 45mm x 1200mm
- Fitted with ABS plastic quick release buckle
- Made from hard wearing split suede

2 2 Extra Large Pockets

Customise with Wallboard Tool Holders



BT-125-4

- Heat sealed and double riveted webbed belt with quick release clips
- Includes 16-015 Hammer Loop
- Robust, reinforced hard wearing split suede

Customise with Wallboard Tool Holders

5 5 Large Pockets



BT-125-2

- Complete with web belt 45mm x 1200mm
- Fitted with ABS plastic quick release buckle
- Made from hard wearing split suede

2 2 Generous Pockets

Customise with Wallboard Tool Holders

ABC-123 Code	Barcode	Description	Ctn
BT-99-2	9315778992213	2 Pocket Suede Nail Bag	5
BT-125-2	9315778992220	2 Pocket Suede Nail Bag	5
BT-125-4	9315778992237	5 Pocket Suede Nail Bag	5

BT-600-M

- Heavy duty leather belt with buckle
- Two fixed hammer loops and a utility pocket
- Top grain, vegetable dyed moccasin leather

5 5 Large Pockets



BT-125-4M

- Durable webbed belt with plastic clips
- Includes 16-015 Hammer Loop
- Manufactured from quality moccasin leather

WBT Customise with Wallboard Tool Holders

5 5 Large Pockets



ABC-123 Code	Barcode	Description	Ctn
BT-125-4M	9315778994408	5 Pocket Moccasin Nail Bag	5
BT-600-M	9315778997737	Premium 5 Pocket Moccasin Nail Bag	5

TOOL HOLDERS

16-015



16-50



16-51



16-020



16-70



SCP8000

ABC-123 Code	Barcode	Description	Ctn
16-015	9315778990738	Hammer Loop	10
16-020	9315778990721	Swinger Hammer Loop	10
16-50	9315778990745	Tin Snips Holder	6
16-51	9315778992046	Utility Knife Holder	6
16-70	9315778999236	Universal Bungee Tool Holder	6
SCP8000	9310679019243	Multi-Purpose Clip 2pkt SafeCorp	1

NO-COAT ULTRATOOLS

ABC-123 Code	Barcode	Description	Ctn
NC-H1	0634678006004	Double Barrel Hopper	2
NC-CRIL	0634678005199	90° Internal Corner Roller No-Coat	1



NC-CRIL



NC-H1

No-Coats 90° inside corner roller assists in delivering the high speed installation of 90° inside Ultratrim and Ultraflex 325 on off angles.

- Squeezes excess compound out behind the corner
- Roller matches the corner profile perfectly

The No-Coat double barrel hopper is designed to coat Ultratrim (inside, outside and bullnose corners) as well as Ultraflex 325 and Ultraflex 450.

- Set up for all angles - no time consuming adjustments
- High volume polyurethane tank

PENCILS & CRAYONS

ABC-123 Code	Barcode	Description	Ctn
15-10	9318924000046	Black Crayon	12
15-11	9318924000015	Blue Crayon	12
15-006	9315778992275	Carpenters Pencil Medium Lead	72
15-008	9315778003216	Mechanical Carpenter Pencil and Refills WBT	25

*Ordered in carton quantities

Mechanical Carpenter Pencil and Refills WBT

Medium-Hard graphite carpenter pencil for universal marking purposes. The graphite automatically breaks when blunt for another sharp tip.



15-10



15-006



15-008

PLASTERBOARD STRIPPER

The Plasterboard Stripper makes precision cuts in 10mm, 13mm or 16mm plasterboard quick and easy.

- Cuts up to 115mm segments
- Perforated wheels cut both sides of the plasterboard
- Measuring increments in both inches and millimetres
- Once cut the piece is snapped off neatly without tearing paper

ABC-123 Code	Barcode	Ctn
BS-21	9315778996891	6

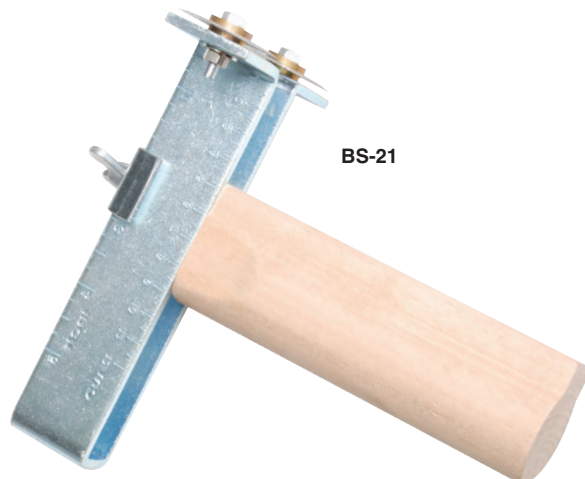

BS-21

POWER LEAD

ABC-123 Code	Barcode	Size	Ctn
PLHD-20	9315778998581	20m	4

- Heavy duty cable
- Clear plug and socket
- Suitable for trade/construction use
- Power on LED warning light
- High visibility colour



RASPS

ABC-123 Code	Barcode	Description	Size	Ctn
21-111	9315778995207	Rasp Wallboard	140mm	2
21-520	9315778995214	Rasp Blade Wallboard	140mm	6

This handy plasterboard rasp tidies up sawn or cut plasterboard edges & assists with creating a set back when installing trims & beads.



21-520



21-111

REPAIR PATCHES

ABC-123 Code	Barcode	Size	Ctn
54-005	049727540055	100 x 100mm	10
54-007	049727540079	200 x 200mm	10



54-005

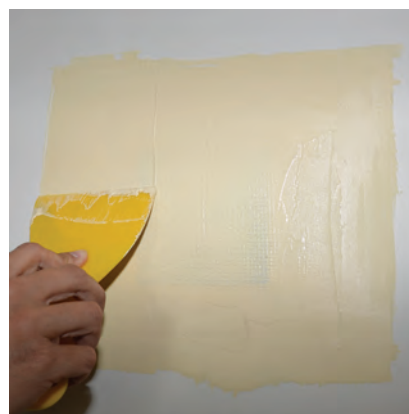
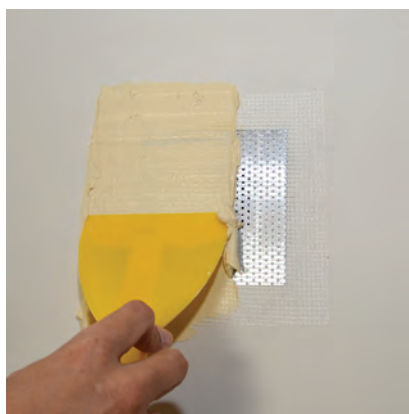

RP-1000

RIVET GUNS & RIVETS

ABC-123 Code	Barcode	Description	Size	Ctn
AS-2730	5013035024717	Heavy Duty Rivet Gun	3, 4, 5mm	3
RP-250	9310679809523	Economy Rivet Gun	3, 4, 5mm	5
RP-1000	9315778994583	Aluminium Pop Rivets 1000pkt	8mm	20



RP-250

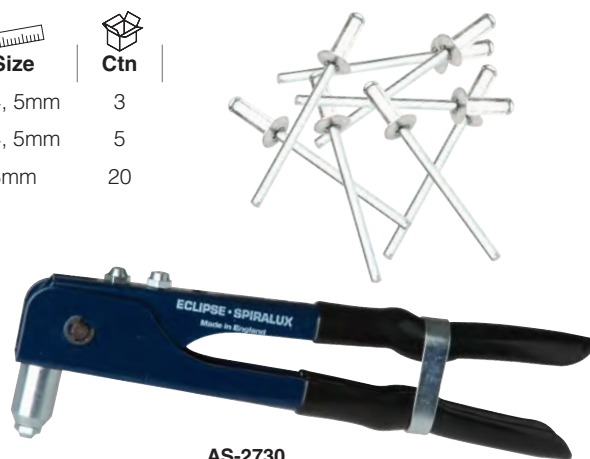

AS-2730

SANDERS

HAND SANDERS SMALL

HS-66



WHS-76



9057



Hand Sanding



Use with Small Sandpaper/ Sanding Mesh (find it on page 7-8)



Use with Small Sanding Mesh (find it on page 7)

6185



9165



Hyde Dust Dogs are the economical way to reduce dust when sanding plasterboard joints. Included in the box: Hyde Dust Dog Hand Sander, 1.8m Vacuum Hose, 2 Vacuum Hose Adapters & 1 sheet of Small Sanding Mesh.

ABC-123 Code	Barcode	Description	Size	Ctn
6185	9315778994309	Aluminium Base Polypropylene Handle Sander Wallboard	230mm	6
HS-66	9315778991216	Aluminium Base Wooden Handle Sander Wallboard	230mm	6
WHS-76	9315778991056	Plastic Sander Wallboard	230mm	10
9165	079423091650	Dust Dog Sander Hyde	230mm	5
9057	079423090578	Polypropylene Sander Hyde	230mm	5

HAND SANDERS LARGE

ABC-123 Code

Barcode

Description

Size

Ctn

HS-72

9315778990042

Red Polypropylene Sander Wallboard

280mm

10



Hand Sanding



Use with Large Sandpaper/ Sanding Mesh (find it on page 7-8)



HS-72

POLE SANDER COMPLETE

Economical pole sanding at it's finest.

ABC-123 Code

Barcode

Description

Ctn

WS-22

9315778994705

Aluminium Head with 1.2m Wood Handle Wallboard

12



Hand Sanding



Use with Small Sandpaper/ Sanding Mesh (find it on page 7-8)

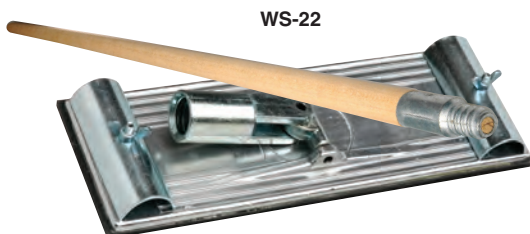

WS-22



WS-22H

POLE SANDER HEADS



72-360

The Radius 360 Pole Sander Head is a unique design that enables the sander head to move around easily in all directions.



Hand Sanding



For use with Super Pads and Mesh
(find it on page 8-11)

- Die cast aluminium head with wide pivot brackets giving the tool unique side to side, up and down, and circular mobility
- The round design minimises flipping



WPS-360

- Rapid smooth sanding
- Quick and easy disc changes



Hand Sanding



For use with Super Pads and Mesh
(find it on page 8-11)

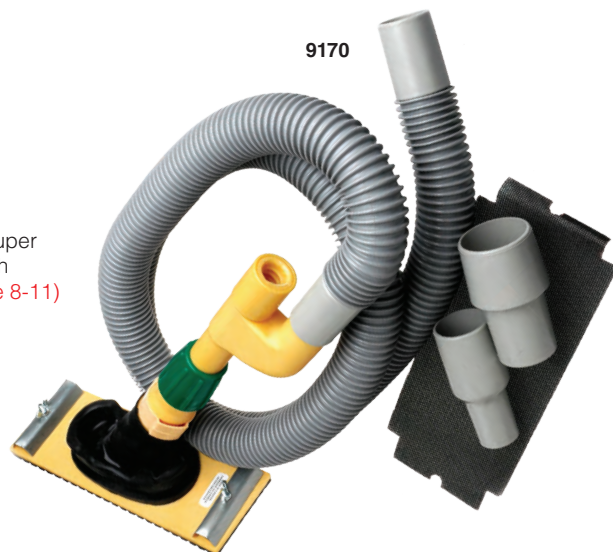

9170

Sand hard to reach areas and reduce onsite dust with the Hyde Dust Dog Pole Sander. Included in the box: Hyde Dust Dog Hand Sander, 1.8m Vacuum Hose, 2 Vacuum Hose Adapters & 1 sheet of Small Sanding Mesh.



Hand Sanding



Use with Small Sanding Mesh
(find it on page 7)



Connects to Vacuum to Reduce Dust



72-540

Trim-Tex Black Widow™ Pro Series Sander has a no flip design and 60% larger sanding surface compared to blocks.



Use with Black Widow Sanding Pads
(find it on page 12)

ABC-123 Code	Barcode	Description	Thread	Size	Ctn
72-360	726372360008	Radius 360° Sanding Head Trim-Tex	Female	225mm	1
72-540	726372005404	Black Widow Pro Series Sander Trim-Tex	Female	225mm	1
WPS-360	9315778002417	Pro Sander 360 Wallboard	Female	225mm	1
9170	079423091704	Head Dust Dog Sanding Head Hyde	Female	230mm	5
WS-22H	9315778992077	Aluminium Sanding Head Wallboard	Female	230mm	12

POLES & ACCESSORIES



WBH-4

- Economical wooden handle ideal for pole sanding and paint rollers
- Male threaded end
- 1.2m long



Fixed Handle



15-345



Telescopic Handle
1.2 > 2.4m

- Made from lightweight aluminium
- Plastic locking nut allowing handle to be extended to desired length for sanding high walls and ceilings from the floor
- Male threaded end



- Suits all telescopic extension handles
- Changes male to a female thread

15-349



72-362

Hook & Loop Foam Adapter for Radius 360 Sanding Head (72-360) Compatible with Wallboard Super Pads, JSD Super Pads and JSD Mesh.

ABC-123 Code	Barcode	Description	Thread	Size	Ctn
WBH-4	9315778996778	Wooden Pole Wallboard	Male	1.2m	6
15-345	9314885020406	Telescopic Aluminium Pole Wallboard	Male	1.2-2.4m	6
72-362	0187691000080	Hook & Loop Foam Adaptor for 72-360 Trim-Tex		225mm	3
15-349	9315778992954	Plastic Thread Adaptor Wallboard			6

SKIMMING KNIVES

SKIMMING KNIFE

Wallboard's Skimming Knives are designed to perfectly coat wide areas with one wipe down for large area smoothing. The blades have rounded edges to stop mud gouging and the shape allows for greater surface contact and blade flex guaranteeing flawless finishing.

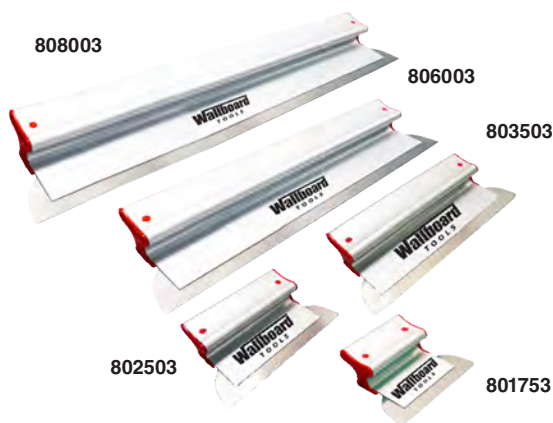

ABC-123 Code	Barcode	Description	Size	Ctn
801753	9315778002196	Skimming Knife 175mm	175mm	1
802503	9315778002219	Skimming Knife 250mm	250mm	1
803503	9315778002226	Skimming Knife 350mm	350mm	1
806003	9315778002233	Skimming Knife 600mm	600mm	1
808003	9315778002493	Skimming Knife 800mm	800mm	1

SKIMMING KNIFE POLE & ADAPTOR



ABC-123 Code	Barcode	Description	Size	Ctn
800010	9315778002240	Skimming Knife Adaptor		1
800020	9315778002257	Skimming Knife Pole	1.23m - 1.86m	1

SKIMMING KNIFE KIT



SKIMMING KNIFE KIT (CONTINUED)

ABC-123 Code	Barcode	Contents Code	Description	Size
800005	9315778003032		SKIMMING KNIFE KIT	
		801753	Skimming Knife 175mm	175mm
		802503	Skimming Knife 250mm	250mm
		803503	Skimming Knife 350mm	350mm
		806003	Skimming Knife 600mm	600mm
		800010	Skimming Knife Adapter	
		800020	Skimming Knife Pole	1.23m - 1.86m
		TC-1200	Tool Case	1200mm

EZYSKIM SKIMMING BLADE KIT

Protect your Skimming Knives with the Wallboard Tools EzySkim Skimming Blade Kit. The EzySkim Knives are designed to increase efficiency and quality of finish. The kit comes complete with 3 popular skimming knives that possess a comfortable grip shape, pole, pole adapter and replacement blade for each size to increase the longevity of the tool. All packed in a sturdy carry case to keep your knives protected when travelling to and from site.

ABC-123 Code	Barcode	Description	Ctn
820005	9315778003223	EzySkim - Skimming Blade Kit WBT	4

EZYSKIM

Protective Case



600mm Skimming Knife



350mm Skimming Knife



Pole & Adapter

250mm Skimming Knife

WATCH ON



SAWS

CORNICE SAWS



FC-2210

- Hardened tempered blade
- Forward and reverse cut
- Aggressive tooth



Rubber Handle



10pt Blade

WS-2210 / WS-2610 / WS-3210



- Designed for cutting ornamental cornice in a large mitre box
- Available in 550mm, 650mm and 800mm blade lengths



Plastic Handle



10pt Blade



9520W

- Finger rests for both left and right handers
- Forward and reverse cut
- Precision cross ground teeth for extra sharpness



Rubber Handle



8pt Blade

ABC-123 Code	Barcode	Description	Size	Ctn
9520W	5012095047858	Rubber Handle Cornice Saw S&J	528mm	10
WS-2210	9315778993807	Plastic Handle Cornice Saw Wallboard	550mm	6
FC-2210	9315778996785	Fast Cut Pro-Grip Cornice Saw Wallboard	560mm	6
WS-2610	9315778993814	Plastic Handle Cornice Saw Wallboard	650mm	6
WS-3210	9315778998857	Plastic Handle Cornice Saw Wallboard	800mm	6

KEYHOLE SAWS



IS-50

- Hard wearing yet economical
- Heat treated steel
- Sharp point for penetrating plasterboard



Wood Handle



10pt Blade



WS-91

- Ergonomically designed handle
- Hardened steel blade and cutting teeth
- Aggressive



Rubber Handle



8pt Blade



9016

- Double-ground high carbon steel teeth cut in both directions
- Used to cut plasterboard, masonite, plywood and timber
- Ideal for cutting out light switches, outlets and access points



Rubber Handle



8pt Blade

ABC-123 Code	Barcode	Description	Size	Ctn
IS-50	9315778992671	Wooden Handle Keyhole Saw Wallboard	150mm	12
WS-91	9315778992695	Pro-Grip Handle Keyhole Saw Wallboard	150mm	6
9016	079423090165	MaxxGrip Keyhole Saw Hyde	150mm	5

RIP SAW



- Solid high impact plastic handle
- Tough all round design
- Stiff blade



Plastic Handle



5PT 5pt Blade

ABC-123
Code

WS-15



Barcode

9315778990028



Description

Heavy Duty Rip Saw Wallboard



Size

375mm



Ctn

6

SCOOPS

ABC-123
Code

PSC-1



Barcode

9315778997980



Size

375mm



Ctn

1



PSC-1

- Soft rubber grip handle
- Hang hook
- Heavy duty galvanising
- 180mm scoop size

BUCKET SCOOP



71165

- Comfortable rubber grip handle
- Stainless steel curved blade
- 165mm scoop size
- Efficiently removes plaster from bucket

ABC-123
Code

71165



Barcode

9315778002745



Size

165mm



Ctn

2

SCRAPERS & SCRAPER BLADES

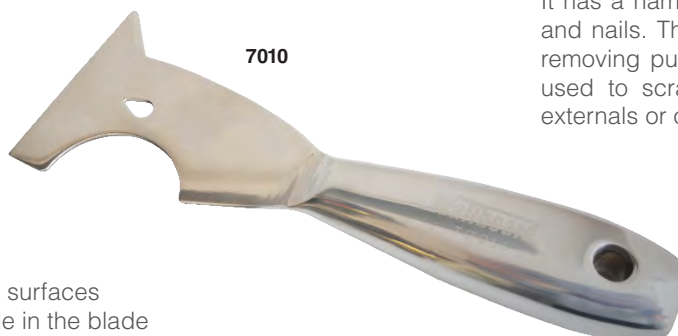

7010

- 6 in 1 Multi Tool
- Scraper blade for cleaning surfaces
- Remove nails using the hole in the blade
- Hammerhead to set nails and screws
- Combination of edges removes putty
- Curved edge for cleaning paint rollers
- Point for opening paint tins

This handy multi functional plasterer's tool has a combination of edges to be used for a variety of uses on the job site. It has a hammer head for setting screws and nails. The scraper blade is great for removing putty and grout, and it can be used to scrape plaster and paint from externals or opening tins.

HAND TOOLS & ACCESSORIES



2980

- 6 tools in 1
- 64mm scraper, putty spreader/remover, paint roller cleaner, patching tool, paint tin opener & hammer head end
- Flexible carbon steel
- Nylon handle



2970

- 5 tools in 1
- 64mm scraper, putty spreader/remover, paint roller cleaner, patching tool & paint tin opener
- Flexible carbon steel
- Nylon handle



12050



10540

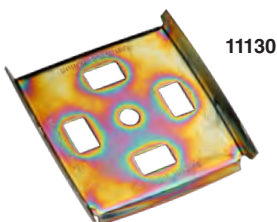

11130



13050



13110



10-50



10-B50

ABC-123 Code	Barcode	Description	Size	Ctn
10-50	9315778002172	Heavy Duty Tungsten Carbide Scraper	50mm	
10-B50	9315778002387	Tungsten Carbide Scraper Replacement Blade	50mm	2
2970	079423029707	5 in 1 Scraper & Painters Tool 64mm Hyde	64mm	5
2980	079423029806	6 in 1 Scraper & Painters Tool 64mm Hyde	64mm	5
10540	079423105401	Hyde 4 Edge Paint Scraper	64mm	5
11130	079423111303	Hyde 4 Edge Paint Scraper Blade for 10540	64mm	10
12050	079423120503	Hyde Scraper	76mm	5
7010	9315778002486	6 in 1 Multi Function Tool	75mm	12
13050	079423130502	Hyde Glass Scraper	110mm	10
13110	079423131103	Hyde Glass Scraper Blades 5pkt for 13050		10

SHEET LIFTERS

The Wallboard Sheet Lifter raises and lowers plasterboard or other types of sheeting by way of a winch system.

PL-3350

- Lifts up to a height of 3.35m
- Tough welded steel construction
- Great safety with a cam lock break
- Tilting cradle for lower loading height and single person operation
- Cradle outriggers stabilise plasterboard sheets
- Dismantles to fit in the boot of most cars
- Maximum sheet size 1.22m x 4.88m

Fast assembly - no tools required

Spare parts available

Safety Certificate Available

Load rating 68kgs

PAGE 77 Parts Diagram Available

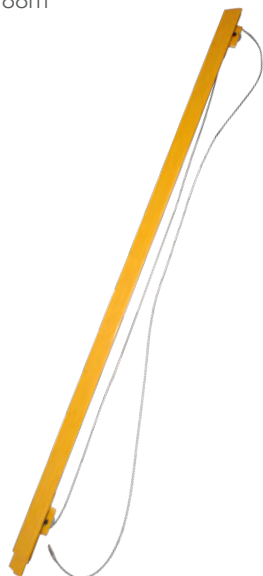

PLE-1200

- Height extension of 1.2m (total lift height of 4.5m when fitted to the Sheet Lifter)
- Tough welded steel construction
- Maximum sheet size 1.22m x 4.88m

WATCH ON



The Roller Lifter uses a "rolling" action to pivot sheeting off the floor.

RL-42

- Tempered all steel construction
- Ribbed back for extra strength
- Vertical top lip lets you guide lifter into place with toe
- Weighted nose keeps lifter in position
- Roller wheel moves board against wall, ready to install
- Length of sheet lifter is 380mm

ML-45

The Mini Lifter makes quick work of manipulating sheets from the ground.

- Strong tempered, all steel construction
- Ribbed back for extra strength
- Compact and lightweight
- Length is 230mm



ABC-123
Code

Barcode

PL-3350	9315778998734
PLE-1200	9315778999922
ML-45	9315778998239
RL-42	9315778998222



Description

Sheet Lifter Wallboard
Sheet Lifter Extension Wallboard
Mini Lifter Wallboard
Roll Lifter Wallboard



Size



Ctn

3.35m	1
1200mm	1
230mm	6
380mm	2

TELPRO PANELLIFT

The PANELLIFT Model 125 by Telpro Inc. is the industry's leading PANELLIFT.

PL-125

- Single person operation
- Works on walls or ceilings
- Tilt allows easy loading and accommodates sloped ceilings
- Fast action, single stage winch with silent cam-lock brake
- Assembles in seconds with no tools
- Max standard reach: 3.35m
- Standard loading height: 0.93m
- Load capacity: 68kg
- Sheet size & capacity: Single plasterboard sheets up to 1.2m x 4.8m



Fast assembly - no tools required



Spare parts available



Load rating 68kgs



Parts Lists Available



ABC-123 Code

PL-125

Barcode

9315778002288

Description

Telpro Panellift

Ctn

1

EDMAPLAC MEGA SHEET LIFTER

The Edmaplac Mega Board Lifter is designed to lift plasterboard in every position; horizontal, angled & vertical

PLM-4.5

- Automatic operation thanks to power drill assistance
- Easy to manoeuvre with foldable feet
- 3 wheels, including 2 wheels with brakes
- The rack and pinion system lifts plasterboard with less effort than other panel lifters
- Innovative braking system with 2 handles (main brake + safety brake) to lower the panel quickly under control



Load rating 80kgs



Fast assembly - no tools required



Max Sheet Size 1.2 x 6m



Parts Lists Available

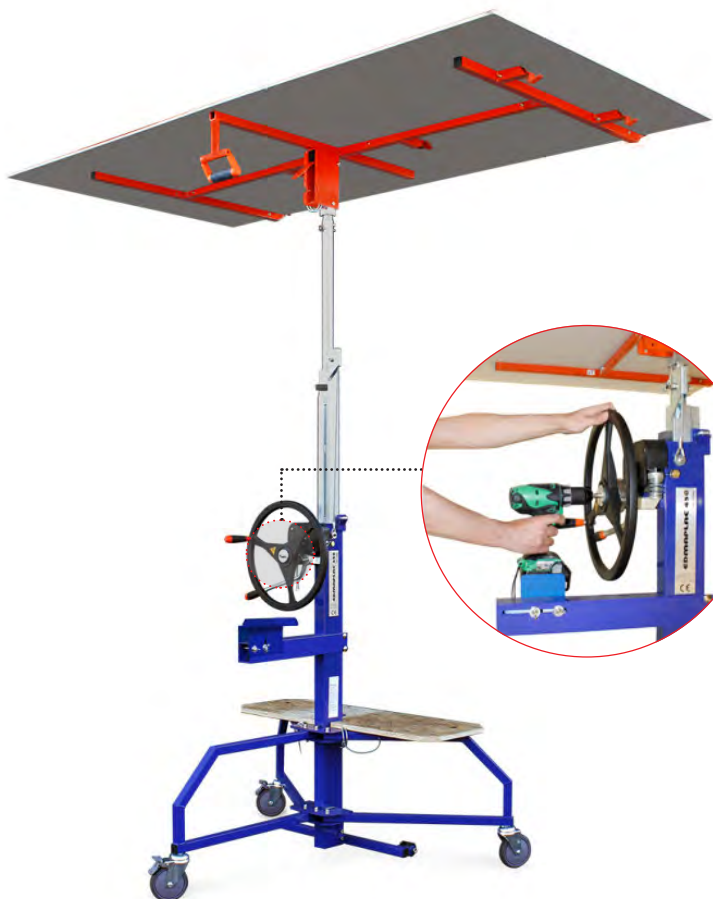

ABC-123 Code

PLM-4.5

Barcode

3476062674553

Description

Edmaplac Mega Sheet Lifter

Ctn

1



SHEET PROP

ABC-123 Code	Barcode	Description	Size	Ctn
15-290	9315778999847	Tele-Prop Wallboard	1.15 - 2.8m	6

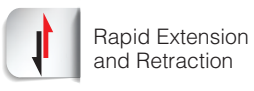

- Extends to 2.8m in height
- Simple pistol grip trigger



15-290



SMALL TOOLS

Wallboard's small tool range are designed for finer detail work

ABC-123 Code	Barcode	Description	Size	Ctn
1640-12	9315778993777	Wallboard Small Tool	12mm	10
1640-20	9315778996792	Wallboard Small Tool	20mm	10
1640-25	9315778993784	Wallboard Small Tool	25mm	10
1140-12	9315778990806	Forged Italian Steel Small Tool	12mm	12
1140-15	9315778995511	Forged Italian Steel Small Tool	15mm	12
1140-20	9315778995528	Forged Italian Steel Small Tool	20mm	12
1140-25	9315778992725	Forged Italian Steel Small Tool	25mm	12



SPONGE MULTI-PURPOSE

- Easy to hold rounded corners
- Ideal for wiping down cornice
- Yellow side for cleaning
- White side for sanding
- Rinse and re-use
- Size 180 x 130 x 50mm

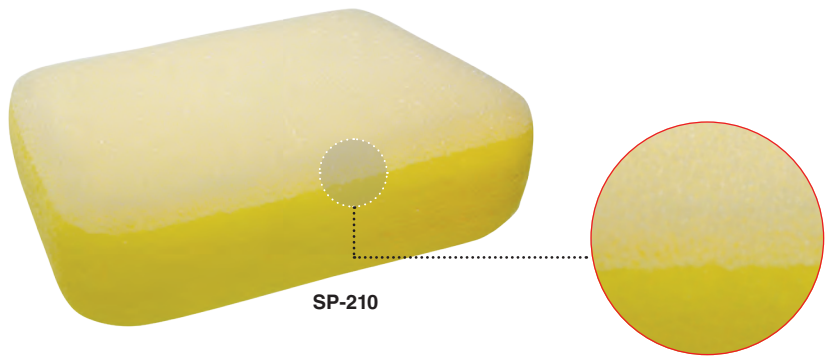

ABC-123 Code	Barcode	Description	Size	Ctn
SP-210	9315778001533	Multi-Purpose Sponge Wallboard	180mm	12

SQUARES



MF-1276

ABC-123
Code MF-1276

Barcode
030553451042

Description
Combination Square Wallboard

Size
150mm

Ctn
6

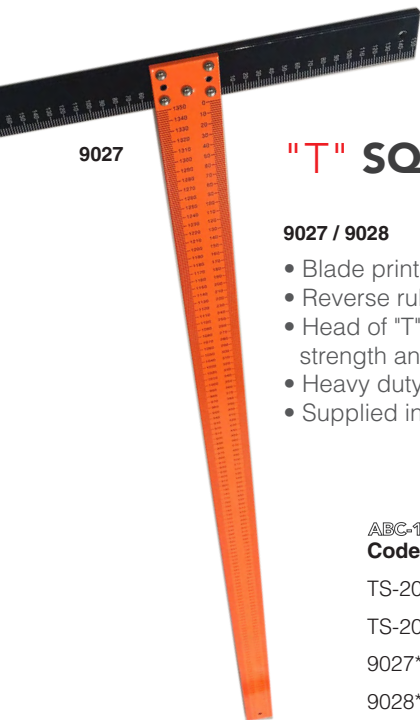

9027

"T" SQUARES

9027 / 9028

- Blade printed in metric
- Reverse ruled for quick measuring in both directions
- Head of "T" Square has a flange to provide added strength and will run along the edge of the sheet
- Heavy duty extrusion
- Supplied in 2 sizes - 1200 & 1350mm



TS-20

TS-20 / TS-20-L

- Lightweight aluminium construction
- "T" Square heads have a flange providing added strength that holds to the edge of the sheet
- Heavy duty extrusion
- Available in 1200 & 1350mm

ABC-123
Code

Barcode

Description

Size

Ctn

TS-20*	9315778990080	Non-Calibrated "T" Square Wallboard	1200mm	5
TS-20-L*	9315778992008	Non-Calibrated "T" Square Wallboard	1350mm	5
9027*	9315778990288	Calibrated "T" Square Wallboard	1200mm	5
9028*	9315778994927	Calibrated "T" Square Wallboard	1350mm	5

* T-Squares are ordered in multiples of 5 for transportation purposes



ADJUSTABLE SQUARES

The adjustable calibrated T square blades are printed with easy to read metric measurements. With markings at 30, 45, 60 and 75 degree angles they're fully adjustable to any angle. With a hard wearing aluminium finish the head and blade lock together to form a perfect 90° angle. Purchase the 1200mm complete square, or add the 1350mm interchangeable blade that's available to purchase separately for cutting larger plasterboard sheets.

ABC-123
Code

Barcode

Description

Size

Ctn

9031	9315778002165	Adjustable T- Square	1200mm	5
9035	9315778002370	Adjustable T- Square - Interchangeable Blade	1350mm	5

STAPLE GUNS



SGP-10

- Powerful driving force
- Tough all metal construction
- Lock down handle
- Comfortable handle shape
- Bottom loading position



6, 8, 10, 12 & 14mm Staples



SGP-20

- Made from durable and lightweight aluminium alloy
- Power selector dial
- Convenient staple refill window
- Easy bottom loading
- Safe handle locking system
- Comfortable rubber grip



Heavy Duty



Fires 6, 8, 10, 12 & 14mm and 16mm, 18 Gauge Brad Nails



RSG-14

- High impact force
- Noise damper
- Recoil free
- Handle lock
- Quick load
- All steel construction



Made in Sweden



Medium Duty



Fires 6 & 8mm Staples



SGP-30

- Direct Drive greatly reduces firing effort
- Forward action suits most hand sizes
- Durable aluminium alloy tool casing
- Convenient rotatable LH/RH belt hook
- Lightweight at 550g



Heavy Duty



6, 8, 10, 12 & 14mm Staples

Rapid



RSG-34

- High impact force
- Noise damper
- Recoil free action
- Adjustable force
- Locking function
- Bottom loading
- All steel construction



Made in Sweden



Heavy Duty



Fires 6, 8, 10, 12 & 14mm Staples

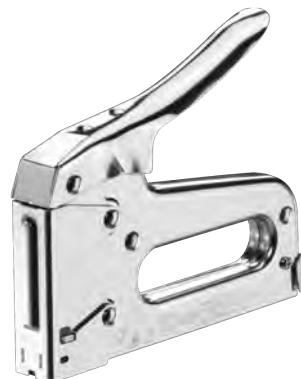

T-50

- All steel construction
- Hardened steel working parts
- Contoured grip
- Easy squeeze operation
- Jam resistant mechanism



Heavy Duty



6, 8, 10, 12 & 14mm Staples



JT-21

- All steel construction
- Compact and lightweight
- Jam resistant
- Built in staple lifter



Light Duty



Fires only Arrow JT-21 staples



T-55

- All steel construction
- Hardened steel working parts
- Easy squeeze operation
- Anti-jam technology
- Handle lock



Medium Duty



6, 8, 10, 12 & 14mm Staples

ABC-123 Code	Barcode	Description	Ctn
SGP-20	9315778996914	Heavy Duty Professional Staple Gun Wallboard	5
JT-21	079055500211	Light Duty Steel Staple Gun Arrow	5
T-50	079055000501	Heavy Duty Staple Gun Arrow	5
T-55	079055000556	Medium Duty Staple Gun Arrow	5
RSG-14	7313465114506	Medium Duty Staple Gun Rapid	5
RSG-34	7313465115503	Heavy Duty Staple Gun Rapid	5
SGP-10	9315778002967	Staple Gun Heavy Duty WBT	5
SGP-30	9315778002974	Staple Gun Direct Drive Heavy Duty WBT	5

STAPLES



RS140-10



WS140-8

WS140-8-5



WS140-10

WS140-10-5

- Wallboard range of staples are designed to fit the Wallboard Professional Staple Gun
- Also fits Rapid RSG-34 staple gun and the Arrow T-50 & T-55 guns
- Chisel Point staples made from galvanised steel
- Available in 2000 & 5000 pack quantities



RS140-10-5



Packaged in protective plastic case

- Made from galvanised steel
- Chisel point
- Available in 2000 & 5000 pack quantities



JT-21-8

- Wire staples
- Flat point bottom
- 1000 per packet
- Available in 8mm
- Use only with JT-21 Staple Gun



T-50-10

- Arrow Staples fit most staple guns
- 8mm & 10mm sizes have divergent point
- Galvanised steel

ABC-123 Code	Barcode	Description	Size	Ctn
WS140-8	9315778992183	Chisel Point Staples 2000pkt Wallboard*	8mm	50
WS140-8-5	9315778996853	Chisel Point Staples 5000pkt Wallboard*	8mm	30
WS140-10	9315778992190	Chisel Point Staples 2000pkt Wallboard*	10mm	50
WS140-10-5	9315778996846	Chisel Point Staples 5000pkt Wallboard*	10mm	20
JT-21-8	079055215165	Wire Staples 1000pkt Arrow	8mm	80
T-50-6	079055500148	Chisel Point Staples 1250pkt Arrow	6mm	80
T-50-8	079055505167	Divergent Staples 1250pkt Arrow	8mm	80
T-50-10	079055500384	Divergent Staples 1250pkt Arrow	10mm	80
T-50-12	079055500124	Chisel Point Staples 1250pkt Arrow	12mm	80
T-50-14	079055509165	Chisel Point Staples 1250pkt Arrow	14mm	80
RS140-6	4051661009723	Chisel Point Staples 2000pkt Rapid*	6mm	50
RS140-8	4051661009730	Chisel Point Staples 2000pkt Rapid*	8mm	50
RS140-8-5	7313463030891	Chisel Point Staples 5000pkt Rapid*	8mm	20
RS140-10	4051661009747	Chisel Point Staples 2000pkt Rapid*	10mm	50
RS140-10-5	7313463030907	Chisel Point Staples 5000pkt Rapid*	10mm	15
RS140-12	4051661009754	Chisel Point Staples 2000pkt Rapid*	12mm	50

*Plastic Cases

STILTS

Plasterers stilts are used to reach higher places without the use of scaffolds, trestles or planks.

WS-1830 /
WS-2440



- Locking strap buckles for comfort and safety
- Upper and lower coil springs for more natural movement
- Includes Work-safe guidance notes
- Available in 450-750mm (medium) and 600-1000 (large)

DSD-1830 /
DSD-2440



- Made from high strength aluminium alloy
- Working parts are cadmium plated steel for long life
- Rubber soles are bonded on, they also prevent slipping
- Heights are adjustable every 50mm
- Strap on adapters come with each set
- Main struts are channel aluminium and adjustable by wishbone spring
- 450-750mm (medium) and 600-1010 (large) sizes



■ Upper foam rubber leg pads are comfortable on the calf



■ Stilt height adjustable every 50mm



Adjustable Heights



PAGE 76 Parts Diagram Available



Adjustable Heights



PAGE 75 Parts Diagram Available

ABC-123 Code	Barcode	Description	Size	Ctn
WS-1830	9315778996242	Medium Adjustable Stilts Wallboard	450-750mm	6
WS-2440	9315778996259	Large Adjustable Stilts Wallboard	600-1000mm	6
DSD-1830	9315778991599	Medium Adjustable Dura-Stilts	450-750mm	6
DSD-2440	9315778994897	Large Adjustable Dura-Stilts	600-1010mm	6

STRAIGHT EDGES

ABC-123 Code	Barcode	Size	Ctn
AG-21	9318428199215	2100mm	6
AG-24	9318428199246	2400mm	6
AG-27	9318428199277	2700mm	6
AG-30	9318428199307	3000mm	6



AG-21

- Lightweight and accurate
- Made from extruded aluminium
- Uses include ruling, cement render screeding for tiling and as a general construction straight edge
- Fitted with rubber end plugs and ribbed on both sides
- Available in 2100, 2400, 2700 & 3000mm lengths

STRING LINES



AS-8100

ABC-123 Code	Barcode	Size	Ctn
AS-8500	9312791001717	50m	6
AS-8100	9312791001700	100m	6

- Braided bricklayers line
- White in colour
- Line has built-in elasticity to help maintain tension and reduce sag
- Available in 50 & 100m lengths

TAPE DUCT

ABC-123
Code
WDT-30

Barcode
9315778001830

Size
48mm x 30m

Ctn
60



WDT-30



MT-36

TAPE MASKING

ABC-123
Code
MT-24

Barcode
721672002979

Size
24mm x 50m

Ctn
36

MT-36

Barcode
721672002955

Size
36mm x 50m

Ctn
24

MT-48

Barcode
721672003044

Size
48mm x 50m

Ctn
24



PT-36B



PT-36C

TAPE PACKING

ABC-123
Code
PT-36B
PT-36C

Barcode
9315778992923
9315778992930

Description
Brown Packing Tape Wallboard
Clear Packing Tape Wallboard

Size
36mm x 75m
36mm x 75m

Ctn
6
6

TAPE MEASURES



10-8025

- Lightweight high strength plastic case
- Toggle lock holds blade securely at any length
- Belt clip included
- Nylon coated blade



Yellow Blade



Metric



UW148MN

- Lightweight, high strength, plastic case in high visibility fluoro colour
- Toggle lock holds blade at any length
- Removable belt clip
- Blade edge marked one side in continuous mm with the other marked each 5mm



Yellow Blade



Metric



ELW148MN

- Vertical printed numbers
- Superior accuracy



White Blade



Metric

ABC-123
Code

Barcode

Description

Size

Ctn

10-8025

Barcode
9315778992251

Wallboard Trade Tape Measure

8m x 25mm

12

UW148MN

Barcode
09337103017415

Ultimate Tape Measure Lufkin

8m x 25mm

10

ELW148MN

Barcode
9337103017392

Ezy Read Tape Measure Lufkin

8m x 25mm

10

TAPING KNIVES BLUE STEEL

LONG HANDLED SERIES WALLBOARD

ABC-123 Code	Barcode	Size	Ctn
JKL-10	9315778001458	250mm	6
JKL-12	9315778001465	300mm	6
JKL-14	9315778001472	350mm	6
JKL-16	9315778003865	400mm	6



Made in USA

- 450mm long handle
- Female thread

JKL-14

WOODEN HANDLE SERIES WAL-BBOARD USA



JK-14



Made in USA

ABC-123 Code	Barcode	Size	Ctn
JK-08	049727180022	200mm	6
JK-10	049727180039	250mm	6
JK-12	049727180046	300mm	6
JK-14	049727180053	350mm	6
JK-18	049727180077	450mm	6
JK-24	049727180091	600mm	6

PRO PROJECT SERIES HYDE

ABC-123 Code	Barcode	Size	Ctn
9223	079423092237	203mm	5
9233	079423092336	254mm	5
9243	079423092435	305mm	5



9232



PRO-GRIP SERIES WALLBOARD

ABC-123 Code	Barcode	Size	Ctn
PK-08	9315778992480	200mm	6
PK-10	9315778992497	250mm	6
PK-12	9315778992503	300mm	6
PK-14	9315778994989	350mm	6



- Flexible Blue Steel
- Pro-Grip Handle
- Hammer Head End

**TAPING KNIVES
STAINLESS STEEL**

PRO STAINLESS SERIES HYDE

- Professional soft-grip tapping knives
- Hammer end for setting nails
- Rivet-free construction
- Stainless steel blade
- Available in 254mm

9343



- Super Strong Stainless Steel
- Soft Grip

ABC-123 Code	Barcode	Size	Ctn
9323	079423093231	203mm	5
9333	079423093333	254mm	5
9343	079423093432	305mm	5

PLASTIC HANDLE SERIES WAL-BBOARD USA

- The same professional quality stainless steel used in the SK series
- Handle is made of lightweight textured plastic with an aluminium blade mounting
- Stainless steel blade
- Available in 150mm, 200mm, 250mm, 300mm & 350mm sizes

HRS-12



- Stainless Steel Blade
- Textured Plastic Handle

ABC-123 Code	Barcode	Size	Ctn
HRS-06	049727210361	150mm	6
HRS-08	049727210385	200mm	6
HRS-10	049727210408	250mm	6
HRS-12	049727210422	300mm	6
HRS-14	049727210446	350mm	6

WOODEN HANDLE SERIES WAL-BOARD USA

- Stainless steel blade mounting welded to a stainless steel blade
- Traditional wooden handle
- Available in 200mm, 250mm & 300mm sizes
- Made in the USA



Tough Stainless Steel



Traditional Wooden Handle



Made in USA



SK-12

ABC-123 Code	Barcode	Size	Ctn
SK-08	049727200010	200mm	6
SK-10	049727200027	250mm	6
SK-12	049727200034	300mm	6

PRO-GRIP SERIES WALLBOARD

- Made from high strength aluminium alloy
- The Pro Grip handle provides superior grip qualities that reduces the chance of fatigue
- Made with high density over mould rubber
- The Pro Grip series of taping knives deliver quality comfort and value
- Corrosion resistant stainless steel blade
- Available in 200mm, 250mm, 300mm and 350mm

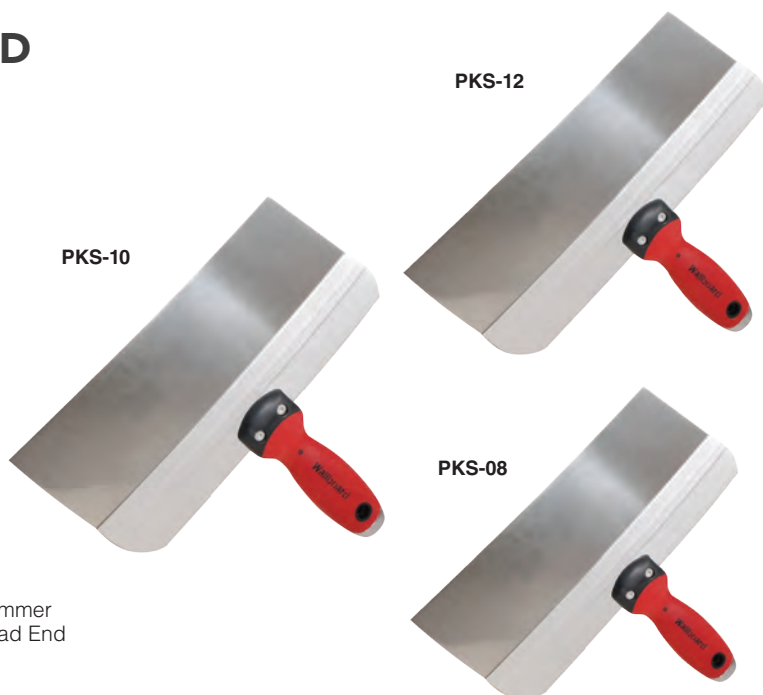

PKS-10

PKS-12

PKS-08

ABC-123 Code	Barcode	Size	Ctn
PKS-08	9315778992565	200mm	6
PKS-10	9315778992572	250mm	6
PKS-12	9315778992589	300mm	6
PKS-14	9315778000109	350mm	6



Tough Stainless Steel



Rubber Handle



Hammer Head End

BOX TRAIL KNIVES STAINLESS STEEL

- Designed to run behind flat boxes to smooth out edges and eliminate bubbles and ripples on walls and ceilings
- Using a Box Trail Knife reduces the need for scraping between coats
- No special poles or handles needed, attaches to any common pole with threaded end
- Lightweight to prevent fatigue



Tough Stainless Steel



BTS-12

ABC-123 Code	Barcode	Size	Ctn
BTS-12	099922384121	300mm	6
BTS-14	099922384145	350mm	6
BTS-16	099922384169	400mm	6

DELKO® TAPER

The Delko® Plastic Taping Tool and Internal Corner Attachment Package enables contractors to finish flat joints, internal corners and square set with one taping tool. The package includes the Delko® Plastic Taping Tool and the Delko® Internal Applicator Attachment.



- Simultaneously apply compound and plasterboard tape to flat joints and internal corners
- Fast, easy and economical plasterboard taping
- Get the patented Delko® Internal Corner Attachment exclusively with the Delko® Taper
- Achieve a smooth, machined finish with the Delko® Flat Applicator
- Adjustable hook and loop side strap
- Reinforced main plastic comfort grip
- Use joint tape rolls up to 150m
- Impressive compound capacity of 2.25kgs

ABC-123 Code	Barcode	Description
DT-AH1	0680596849124	Delko Plastic Taping Tool

DELKO® ZÜNDER®

The Zünder® has revolutionised taping. Zünder® features the doubled ended Delko® applicator which allows for simultaneous application of compound and joint tape on flat joints, internal corners and square sets in minutes – eliminating messy and time consuming adjustments. It has been meticulously designed by a professional for plastering professionals around the world.

- Manufactured from durable Polycarbonate ABS
- Double ended Delko® Applicator Attachment
- Two adjustable soft grip handles (on either side of the tool)
- Right or left hand use
- Compound flow adjustment dial (which is always accessible)
- Fast access for loading and cleaning with a single clip design
- Holds rolls of joint tape up to 150m
- Designed to be used with paper tape and FibaFuse paperless joint tape
- Tool weight (empty): 1.3kgs*
- High capacity: 2.2L / 2.5kg*

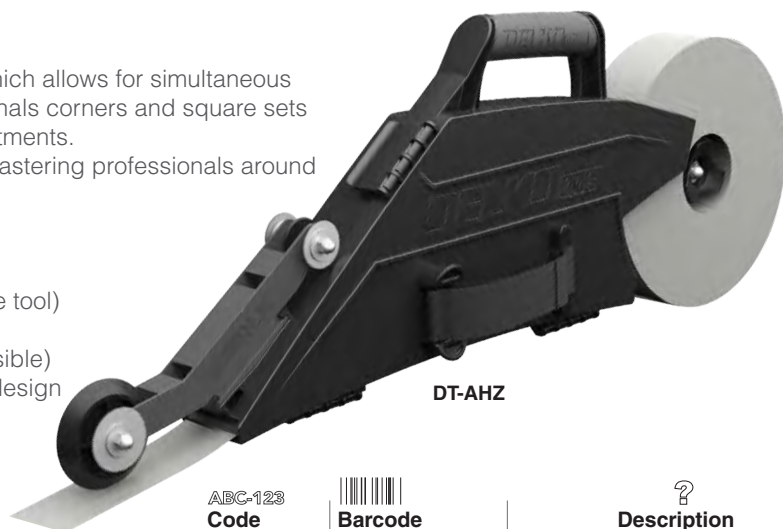

ABC-123 Code	Barcode	Description
DT-AHZ	0793579749714	Delko Zunder Taping Tool

DELKO® HYBRID



The Delko® Hybrid taper has fused the compact size of the Delko® Taper with the professional features found on the ZÜNDER®. Quickly switch between taping flat joints and internal corners with the patented, double ended ZÜNDER® applicator with more control than ever before. Alternate your grip between the large, comfortable top handle and the adjustable canvas handle positioned on the right hand side of the body. We listened to you, the trades people. Delko® Hybrid is everything you love about our taping tools, in one, compact package.

- Made from durable ABS
- Fast access to the inside of the tool via Delko's tough speed clips
- Compact mud bath design with a compound capacity of 2.25kgs
- Use joint tape rolls up to 150m in length – and not just paper, try Delko Hybrid with other tapes like FibaFuse
- Mud control dial allows you to make subtle or large changes to compound flow
- Experience maximum control. Switch between the adjustable canvas handle on the right hand side of the Hybrid, or the large, comfortable handle at the top
- Change between flat joints and internal corners with a flick of your wrist using the patented double ended Delko® Applicator Attachment

ABC-123 Code	Barcode	Description
DT-HB1	0072632835053	Delko Hybrid Taping Tool

DELKO® HOLSTER

PUT YOUR DELKO® TAPING TOOLS ON HANDS FREE!

The Delko® Tools Holster allows you to carry your Delko® Taping Tool in comfort while freeing up your hands to wipe down taped joints. A great solution for holding your Delko® Tool while carrying out work on stilts.

- Compatible with Zünder® by Delko® Tools
- Easy access for drawing and reholstering your Delko® Taping Tool
- Comfortable back support
- Leg strap
- Durable material
- Easy to clean
- Lightweight
- Ideal for stilt users



ABC-123
Code

Barcode

Description

DT-HOL1

0793579749721

Delko Taper Holster

DELKO® PRO PACK

The Delko® Pro Pack is the complete drywall taping kit. Inside the box you will find everything you need to get taping.

- 1 x DELKO® ZÜNDER®
- 1 x DELKO® HOLSTER
- 1 x DELKO® TURBO
- 1 x DELKO® PUMP
- 1 x DELKO® BLADE



ABC-123
Code

Barcode

Description

DT-PRO1

0072632835046

Delko Pro Pack



Established in 2009 DELKO® Tools had a vision of innovating drywall tools for tradesmen designed and tested by tradesmen. DELKO® Tools is proud to be 100% Australian owned and operated.

EDMA PLASTIC TAPER

The Edma Taper is lightweight, weighing in at only 1.2kg and can conveniently be used both left or right handed. Filling the taper is super easy, with bucket hooks, a hinged door and even a compound tube filling point. There is also a featured creaser wheel for taping the internals and flow adjuster to get the perfect amount of compound distribution across the tape. The taper holds up to 2.5kg of compound with 150m joint tape capacity. The Edma Plastic Taper is the ultimate banjo and professionally gets the taping job done.



HT750



2.5 kg capacity



Tape Coat

ABC-123
Code



3476063679557



Description

Edma Plastic Taper



Ctn

6

PLASTIC TAPING TOOL

- Applies tape and compound in one easy step
- Adjustable nylon handle fits different hand sizes
- Use with 75m & 150m rolls of paper tape and 75m rolls of FibreFuse joint tape
- Stainless gears automatically grip and dispense tape onto surface
- Control knob allows you to get an accurate and consistent coating of mud under the tape



HT650



2.3 kg capacity



Tape Coat

ABC-123
Code



9315778998888



Description

Wallboard Plastic Taping Tool



Ctn

6

THREAD ADAPTOR



15-349

This adaptor converts male to a female thread.

ABC-123 Code	Barcode	Description	Ctn
15-349	9315778992954	Thread Adaptor Plastic Wallboard	6

TIE DOWNS

The QUIK STRAP range is made tough and designed to suit most contractors' needs. These tie downs are supplied with high quality hardware and strong hi-vis polyester webbing. The ratchet versions are supplied with a handy storage case.

CAM BUCKLE TIE DOWN

ABC-123 Code	Barcode	Description	Size
602525	9315778002653	Cam Buckle Tie Down	25mm x 2.5m



- 2.5m x 25mm
- 160kg Lashing Capacity
- Single Pack

602525

RATCHET TIE DOWN

ABC-123 Code	Barcode	Description	Size
602542	9315778002646	2pkt Ratchet Tie Down Standard	25mm x 4.2m
602742	9315778002639	2pkt Ratchet Tie Down Heavy	27mm x 4.2m

- 4.2m x 25mm
- 227kg Lashing Capacity
- Two Pack

- 4.2m x 27mm
- 750kg Lashing Capacity
- Two Pack



602542



602742

TIN SNIPS



W-3R

- Self opening
- Safety latch
- Compound lever action



Heavy Duty



Spring Return



Cuts Straight



Heavy Duty



Spring Return



Cuts Left & Straight



M-1R



M-2R



M-3R



Heavy Duty



Spring Return



Cuts Right & Straight

- Tough wear-resistant steel to withstand the severe strain of cutting curves
- Plastic grips for added comfort and safety
- Cuts up to 1.2mm sheet metal



Heavy Duty



Spring Return



Cuts Straight

ABC-123
Code



Barcode



Description



Ctn

ABC-123 Code	Barcode	Description	Ctn
W-3R	9315778995382	Straight Cut Tin Snips with holster Wallboard	12
M-1R	9337103701260	Left & Straight Cut Tin Snips Wiss	12
M-2R	9337103701284	Right & Straight Cut Tin Snips Wiss	12
M-3R	9337103701307	Straight Cut Tin Snips Wiss	12



13-742

TRESTLES

- Strong and durable steel construction
- Intermediate cross bars for lower working platforms
- Hinges that fold for convenient carrying
- Available in sizes 900, 1200, 1500 & 1800mm

ABC-123
Code



Barcode



Size



Ctn

ABC-123 Code	Barcode	Size	Ctn
13-740	9315778990370	900mm	1
13-742	9315778990240	1200mm	1
13-743	9315778996822	1500mm	1
13-744	9315778990172	1800mm	1



Safety Certificates Available

TROWELS

CURVED CARBON STEEL 200MM BLADE

WBC-200



- Carbon steel
- Curved blade
- 200mm long



Plastic Handle



Carbon Steel



WTC-200



Carbon Steel



Rubber Handle

ABC-123
Code



Barcode



Description



Ctn

WTC-200

9315778998680

Wallboard Trowel with Pro-Grip Handle

6

WBC-200

9315778990936

Wallboard Trowel with Plastic Handle

10

CURVED CARBON STEEL 280MM BLADE

- Curved carbon steel blade
- 280mm in length

WBC-280



Carbon Steel



Plastic Handle



Plastic Tang



WTC-280



Carbon Steel



Rubber Handle

ABC-123
Code



Barcode



Description



Ctn

WTC-280

9315778998727

Trowel Pro-Grip Handle Wallboard

6

WBC-280

9315778990943

Trowel Plastic Handle Wallboard

10

CURVED STAINLESS STEEL 200MM BLADE

WTC-200S



- Curved blade style
- Robust stainless steel blade with alloy tang
- 200mm long



Rubber Handle



Stainless Steel

ABC-123
Code



Barcode



Description



Ctn

WTC-200S

9315778998673

Wallboard Trowel with Pro-Grip Handle

6

CURVED STAINLESS STEEL 280MM BLADE

- Curved blade for crowning plaster joints
- Stainless steel with alloy tang
- 280mm long blade



Rubber Handle



Stainless Steel

WTC-280S



ABC-123
Code



Barcode



Description



Ctn

WTC-280S

9315778998710

Wallboard Trowel with Pro-Grip Handle

6

STRAIGHT CARBON STEEL 200MM BLADE



WTS-200

- Robust straight blade
- Carbon steel
- 200mm long blade



Carbon Steel



Rubber Handle



WBS-200



Plastic Tang



Plastic Handle



Carbon Steel

ABC-123 Code	Barcode	Description	Ctn
WTS-200	9315778998666	Wallboard Trowel with Pro-Grip Handle	6
WBS-200	9315778990950	Wallboard Trowel with Plastic Handle	10

STRAIGHT CARBON STEEL 280MM BLADE



WTS-280



Carbon Steel



Rubber Handle



131-OOR



Carbon Steel



Rubber Handle

ABC-123 Code	Barcode	Description	Ctn
WTS-280	9315778998703	Wallboard Trowel with Pro-Grip Handle	6
131-OOR	5012095048701	Tyzack Trowel with Rubber Handle	6

STRAIGHT STAINLESS STEEL TROWELS

- Straight trowel
- Long Blade Size (450mm, 500mm or 600mm)
- Stainless Steel



Stainless Steel



Textured Plastic Handle



WTS-450S



WTS-600S



WTS-500S

ABC-123 Code	Barcode	Description	Ctn
WTS-450S	9315778003186	Trowel 450mm Straight P/Hdl S/S WBT	6
WTS-500S	9315778003193	Trowel 500mm Straight P/Hdl S/S WBT	6
WTS-600S	9315778003209	Trowel 600mm Straight P/Hdl S/S WBT	6

STRAIGHT STAINLESS BLADES



Stainless Steel



Rubber Handle

- Straight blade
- Stainless steel with alloy tang
- 200mm, 280mm & 355mm long
- Comfortable rubber grip
- Robust design

WTS-280S



WTS-200S



WTS-355S



Stainless Steel



Rubber Handle

- Economical and durable
- Straight, stainless steel blade
- 280mm x 118mm in size
- Ribbed blue plastic handle

BW-280S



ABC-123 Code	Barcode	Description	Ctn
WTS-200S	9315778998659	Wallboard Trowel with Pro-Grip Handle	6
WTS-280S	9315778998697	Wallboard Trowel with Pro-Grip Handle	6
WTS-355S	9315778998864	Wallboard Trowel with Pro-Grip Handle	6
BW-280S	9315778993791	Wallboard Trowel with Plastic Handle	10

UNI ADAPTOR

This Uni Adapter is designed for attaching many different types of tools to the end of an extension pole.



Made in Australia

- Features a built-in locking mechanism that will hold tools at a desired angle
- Made in Australia from heavy duty plastic
- Extend your taping knife - check pages 63-65 for our taping knife range

ABC-123 Code

UNI-1



Barcode

9315778993753



Ctn

12



UNI-1

WISE GRIPS

Get a quick grip with these handy Vice Grips.

- Excellent for working with smaller pieces or in tight spaces
- Locks and unlocks with one hand
- Once adjusted the tool stays in position for repeat work
- Length 150mm
- Jaw adjustment 0-50mm

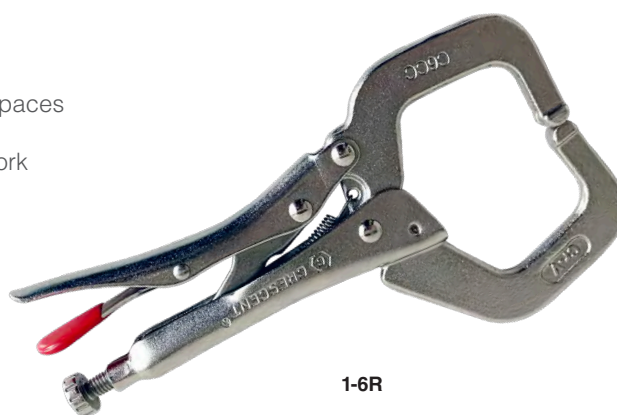

ABC-123
Code

1-6R



Barcode

038548000176



Description

Vise Grips "C" Clamp



Size

150mm



Ctn

5

WALL MESH

Wallboards Fibreglass Wall Mesh is designed to strengthen render surface and corner applications.

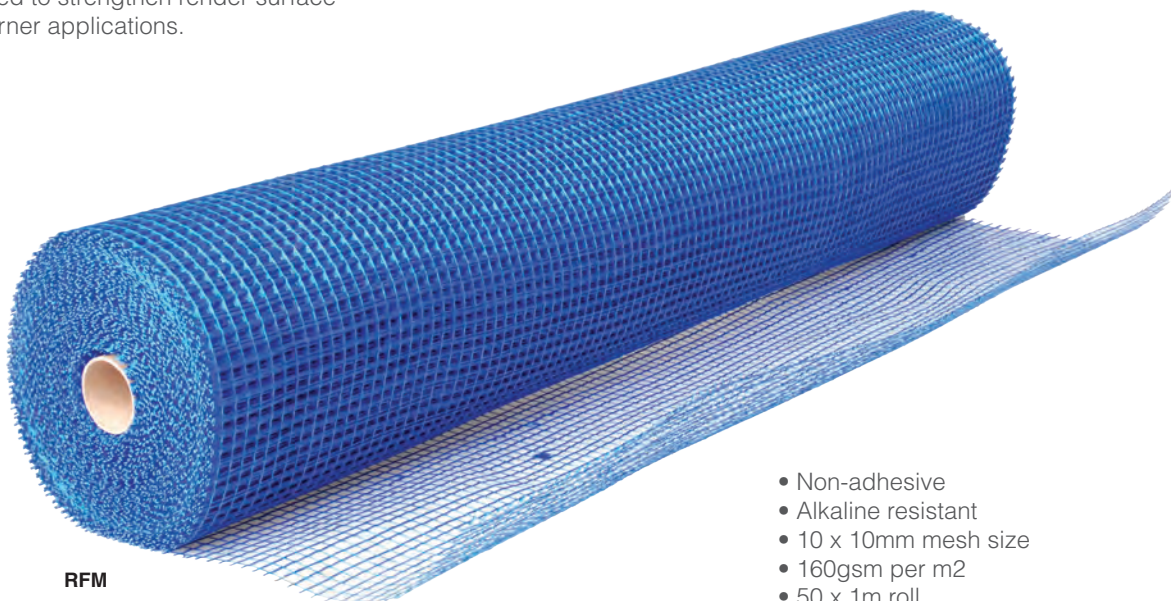

- Non-adhesive
- Alkaline resistant
- 10 x 10mm mesh size
- 160gsm per m²
- 50 x 1m roll

RFM

ABC-123
Code

RFM-10



Barcode

9315778998055



Description

Fibreglass Wall Mesh 160g/m² 10x10 Reinforced



Size

1m x 50m



Ctn

2

DURA STILTS (III) DSD-1830 / DSD-2440

Spare Parts Diagram

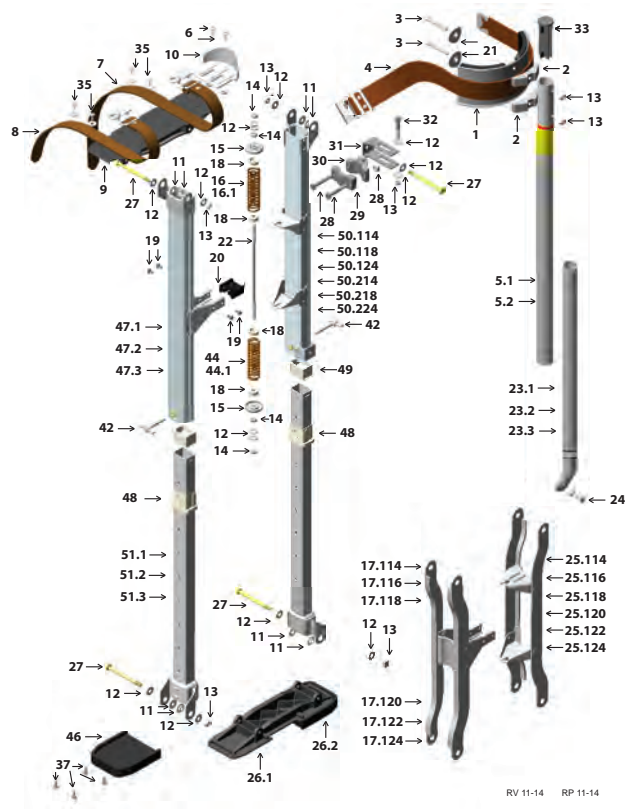

Use only genuine Dura Stilts spare parts. Using other brands parts on Dura Stilts may affect the operation of the product and void warranty.

■ DURA STILTS (III) SPARE PARTS

Code	Description
DSP-1	Leg band with pad
DSP-2	Leg band spacer
DSP-3	1/4-20 x 2" flat head phillips screw with lock nut
DSP-4	Leg strap and buckle
DSP-5A	1 1/8 O.D upper strut tube (DSD-1422 & DSD-1830)
DSP-5B	1 1/8 O.D upper strut tube (DSD-2440)
DSP-6	Truss head screw with nut
DSP-7	Arch/toe strap
DSP-9	Floor plate
DSP-10	Adjustable heel bracket
DSP-11	Nylon leg bearing
DSP-12	1/4" flat washer
DSP-13	1/4-20 lock nut
DSP-14	1/4-20 hex nut
DSP-15	Spring adjuster
DSP-16	Upper coil spring with bearings (dark brown)
DSP-18	Nylon spring bearing
DSP-19	No 8 X 3/8 self threading - DS-III
DSP-20	Spring divider
DSP-21	Large leg band support washer - DS-III
DSP-22	1/4 X 7 7/8 stud bolt threaded
DSP-23A	1" o.d. lower strut tube (DS4-1422)
DSP-23B	1" o.d. lower strut tube (DS4-1830)
DSP-23C	1" o.d. lower strut tube (DS4-2440)
DSP-24	1/4-20 x 9/16" hex bolt, washer & lock nut
DSP-26A	Floor plate only
DSP-26B	Floor plate with soles mounted
DSP-27	1/4-20 x 3-1/8" cap screw
DSP-28	1/4-20 x 5/8 cap screw with DS-III
DSP-29	Tube clamp (A) - DS-III
DSP-30	Tube clamp (B) - DS-III
DSP-31	Clamp bracket - DS-III
DSP-32	1/4-20 x 5/8 cap screw with - DS-III
DSP-33	Upper strut tube cap/plug - DS-III

Code	Description
DSP-34	Shoe mounting bolts & nuts - DS-III
DSP-35A	Strap mounting screw with washer
DSP-36	No 8 strap washer
DSP-37A	No 8 x 1/2" screw
DSP-37B	No 8 x 3/8 screw
DSP-42	Wing bolt
DSP-44	Lower coil spring (light brown)
DSP-45	Entire spring assembly
DSP-46A	Replacement rubber sole with screws
DSP-47A	Forward adjustable leg (DSD-1422)
DSP-47B	Forward adjustable leg (DSD-1830)
DSP-47C	Forward adjustable leg (DSD-2440)
DSP-48	Large nylon extension tube sleeve (lower)
DSP-49	Small nylon extension tube sleeve (upper)
DSP-50A-1	Left rear adjustable leg (DSD-1422)
DSP-50A-2	Right rear adjustable leg (DSD-1422)
DSP-50B-1	Left rear adjustable leg (DSD-1830)
DSP-50B-2	Right rear adjustable leg (DSD-1830)
DSP-50C-1	Left rear adjustable leg (DSD-2440)
DSP-50C-2	Right rear adjustable leg (DSD-2440)
DSP-51A	Extension tube (DSD-1422)
DSP-51B	Extension tube (DSD-1830)
DSP-51C	Extension tube (DSD-2440)
DSP-54A	Strap mounting bolt package
DSP-55A	Sole mounting screw package
DRK01	Leg Strap Replacement Kit
DRK02	Foot Strap Replacement Kit
DRK03	Nylon Sleeve Replacement Kit
DRK04	Coil Spring Replacement Kit
DRK05	Spring Assembly Kit
DRK07	Sole Replacement Kit
DRK09	Wing Bolt Replacement Kit
DRK10	Foot Plate Assembly Kit

WALLBOARD STILTS WS-1830 / WS-2440

Spare Parts Diagram

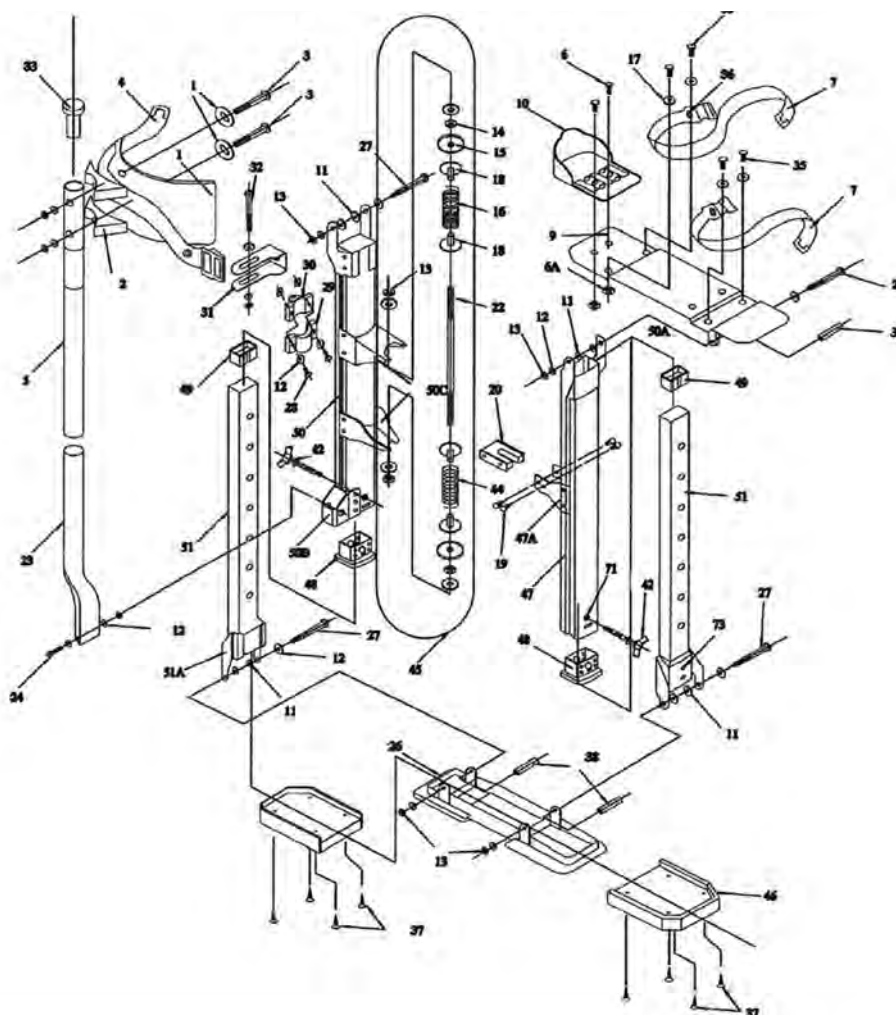

Use only genuine Wallboard Stilts spare parts. Using other brands parts on Wallboard Stilts may affect the operation of the product and void warranty.

WALLBOARD STILTS SPARE PARTS

Code	Description	Code	Description
WSP-1	Leg band with pads	WSP-26	Nylon floor plate
WSP-2	Leg band spacer	WSP-27	1/4"-20*3 1/8" cap screw
WSP-3	1/4"-20*2 1/16" flat head screw with lock nut	WSP-29	Round-lock tube clamp left
WSP-4	Leg strap and buckle	WSP-30	Round-lock tube clamp right
WSP-5-1830	1 1/8" upper strut tube (WS-1830)	WSP-31	Metal clamp bracket 2mm
WSP-5-2440	1 1/8" upper strut tube (WS-2440)	WSP-33	Upper strut tube clamp plug
WSP-6	No 10 10-24*1/2 machine screw with nut	WSP-35	Strap mounting screw
WSP-6A	1/4"-20*3/16 nylon lock nut	WSP-36	Strap washer
WSP-7	Arch strap with buckle	WSP-37	Sole mounting screw
WSP-9	Nylon foot plate	WSP-38	Strap mounting nylon sleeve
WSP-10	Adjustable heel bracket	WSP-42	1/4"-20*1 9/16" wing bolt
WSP-11	Nylon leg bearing	WSP-44	Lower coil spring (Zinc plated)
WSP-12	1/4" flat washer	WSP-45	Entire spring assembly
WSP-13	1/4"-20*H8 nylon lock nut	WSP-46	Replacement sole with screws
WSP-14	1/4"-20*H5 hex nut	WSP-48	Downward large nylon sleeve
WSP-15	Spring adjuster	WSP-49	Upward small nylon sleeve
WSP-16	Upper coil spring (dark brown)	WSP-50-18F	Inter-lock front outward leg extension (WS-1830)
WSP-17	3/4**7/32" strap mounting metal plate	WSP-50-18L	Inter-lock rear outward leg extension left (WS-1830)
WSP-18	3/8" self threading screw	WSP-50-18R	Inter-lock rear outward leg extension right (WS-1830)
WSP-19	3/8" self threading screw	WSP-50-24F	Inter-lock front outward leg extension (WS-2440)
WSP-20	Spring divider	WSP-50-24L	Inter-lock rear outward leg extension left (WS-2440)
WSP-21	1 2/16**5/16**1/16" large leg band washer	WSP-50-24R	Inter-lock rear outward leg extension right (WS-2440)
WSP-22	1/4 X 7 7/8 stud bolt threaded	WSP-51-1830	Inner extension tube (WS-1830)
WSP-23-1830	Inter-lock 1"O.D lower strut tube (WS-1830)	WSP-51-18L	Inner leg extension tube (WS-1830)
WSP-23-2440	Inter-lock 1"O.D lower strut tube (WS-2440)	WSP-51-2440	Inner extension tube (WS-2440)
WSP-24	1/4"-20*1 9/16" half-threaded cap screw	WSP-51-24L	Inner leg extension tube (WS-2440)

WALLBOARD SHEET LIFTER PL-3350

Spare Parts Diagram

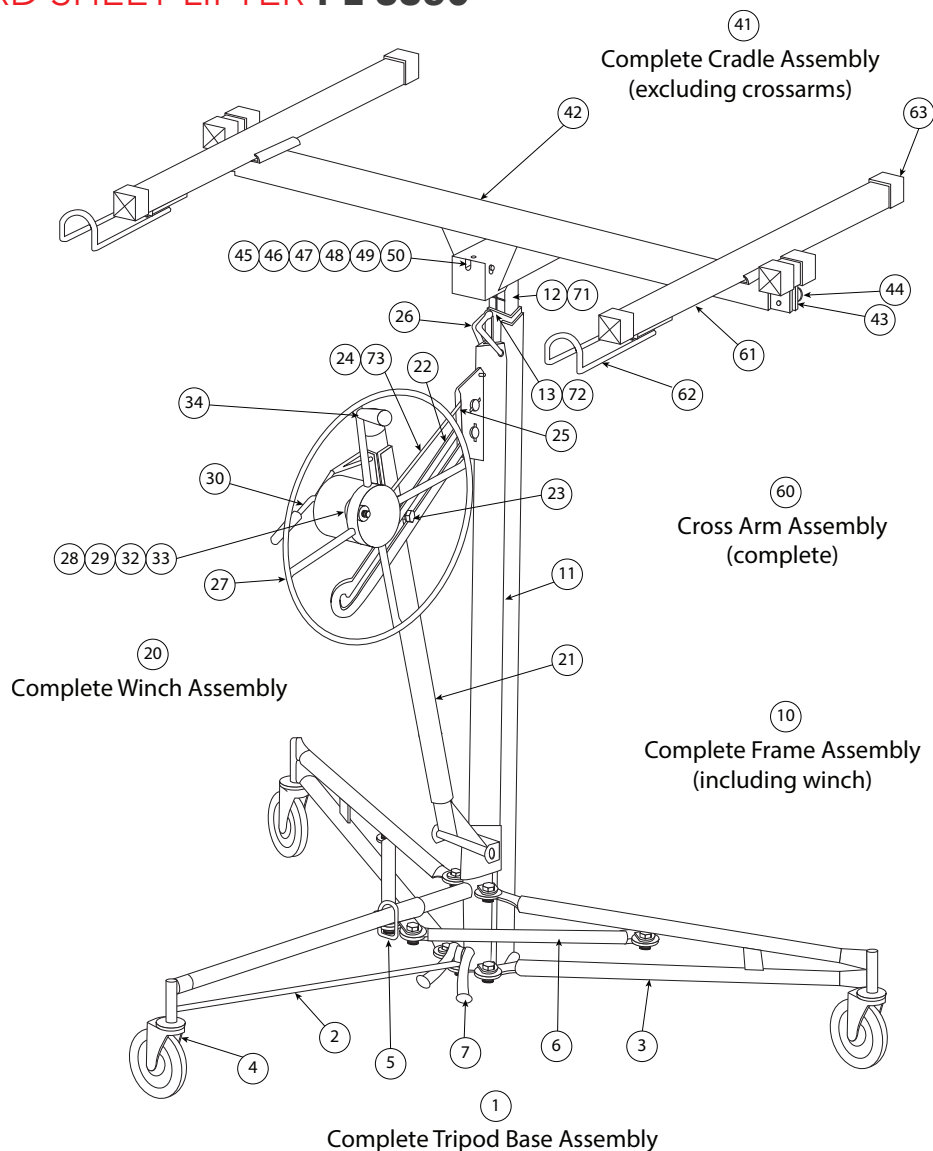

WALLBOARD SHEET LIFTER SPARE PARTS

Code	Description	Code	Description
PL-01	Tripod base assembly complete	PL-32	Brake arm tension spring
PL-02	Centre leg with fasteners	PL-33	Brake hub with bolts
PL-03	Outer leg with fasteners	PL-34	Winch wheel handle
PL-04	Caster	PL-41	Cradle assembly complete
PL-05	Tension spring - slide yoke ring	PL-42	Cradle body
PL-06	Tie arm with fasteners	PL-43	Outrigger lock pin with spring and clip
PL-07	Rubber backstop	PL-44	Outrigger with end caps
PL-10	Frame assembly complete with winch assembly	PL-45	Cradle mounting head assembly complete
PL-11	Frame housing	PL-46	Mounting head body
PL-12	Telescoping section - inner	PL-47	Cradle tilt latch with fasteners
PL-13	Telescoping section - outer with pulley	PL-48	Tension spring
PL-20	Winch assembly complete	PL-49	Compression spring
PL-21	Winch post with pin and fasteners	PL-50	Hinge pin with bolts
PL-22	Slide bar with axle and pin	PL-60	Crossarm assembly complete
PL-23	Slide bar lock with fasteners	PL-61	Crossarm body
PL-24	Cable	PL-62	Panel support hook with fasteners
PL-25	Cable pulley with axle and pins	PL-63	Crossarm end cap
PL-26	Retaining hook	PL-1200	Panel Lift Extension 1200mm
PL-27	Winch wheel with flange bearings	PL-71	Extension telescoping section - inner
PL-28	Bushing	PL-72	Extension telescoping section - outer with pulley
PL-29	Bolt with nut and washer	PL-73	Extension cable
PL-30	Brake arm assembly and lining with fasteners		

Use only genuine Wallboard Sheet Lifter spare parts. Using other brands parts on Wallboard Sheet Lifter may affect the operation of the product and void warranty.

TELPRO PANELLIFT PL-125

Spare Parts Diagram

■ WALLBOARD SHEET LIFTER SPARE PARTS

Code	Description	Code	Description
1-02	Pull pin with fasteners	3-07	Tension spring "B"
1-06	End caps	3-08	Brake handle cover
2-05	Cable 13.5' 1/8" aircraft	4-06	Caster "5"
2-06	Cable sheave with axle and pins (3 total)		

EDMAPLAC MEGA BOARD LIFTER PLM-4.5

Spare Parts Diagram

■ WALLBOARD SHEET LIFTER SPARE PARTS

Code	Description	Code	Description
PLM01	Brake lining	PLM05	Retractable stop 80mm
PLM02	Metallic wire	PLM09	Complete set of bearings
PLM03	Wheel with brake	PLM19	Brake lever
PLM04	Wheel with swivel		